

190501 Velomitor CT Transducer

Datasheet

Bently Nevada Machinery Condition Monitoring

141636 Rev. AD



Description

The Velomitor CT Velocity Transducer is a low-frequency version of our standard Velomitor Piezo-velocity Sensor. Its design specifically measures casing vibration velocity on cooling tower and air-cooled heat-exchanger fan assemblies that operate at or above 90 rpm (100 to 300 rpm typical).

The Velomitor CT Transducer can measure vibration amplitudes at these frequencies as well as the vibration frequencies generated by the fan motor and speed reducer.



Most common machine malfunctions (unbalance, misalignment, etc.) occur on the rotor and originate as an increase (or at least a change) in rotor vibration. For any individual casing measurement to be effective for overall machine protection, the system must continually transmit a significant amount of rotor vibration to the machine casing, or mounting location of the transducer.

In addition, be careful to install the accelerometer transducer on the bearing housing or machine casing. Improper installation may decrease the transducer amplitude and frequency response and/or generate false signals that do not represent actual vibration. Refer to the appropriate instruction manuals and Application Notes.

Upon request, Bently Nevada provides engineering services that can identify the appropriate machine housing measurements and installation assistance if needed.



Specifications

Parameters are specified from +20°C to +30°C (+68°F to +86°F) and 100 Hz unless otherwise indicated.

 Operating the transducer outside the specified limits will result in false readings or loss of machine monitoring.

Electrical

Sensitivity	3.94 mV/mm/s (100 mV/in/s) ±5%.
Frequency Response	3.0 Hz to 900 Hz (180 to 54,000 cpm) ±1.0 dB 1.5 Hz to 1.0 kHz (90 to 60,000 cpm) ±3.0 dB
Temperature Sensitivity	-8% to +5% typical over the operating temperature range.
Velocity Range	63.5 mm/s pk (2.5 in/s pk) see Operating Range for Metric Units on page 13. See Operating Range for English Units on page 14. Vibration components in excess of 10g pk above 1 kHz can significantly reduce this range.
Transverse Response	Less than 5% of the axial sensitivity.
Amplitude Linearity	±2% to 63.5 mm/s pk (2.5 in/s pk)
Mounted Resonant Frequency	9 kHz, minimum (stud mounted, except quick disconnect)
Output Bias Voltage	10.1 Vdc ± 1.0 Vdc, Pin A referenced to Pin B
Dynamic Output Impedance	<400 Ω typical
Broadband	0.229 mm/s (0.009 in/s) pk.

Noise Floor (1.5 Hz to 1 kHz)	For more information, see Typical Low Frequency Noise Floor on page 15.
Base Strain Sensitivity	0.43 mm/s/μstrain (0.017 in/s/μstrain).
Grounding	Internal electronics are isolated from case.
Maximum Cable Length	305 metres (1,000 ft.) of cable (part number 02173006) with no degradation of signal.

 Maximum continuous length of cable available is 91.44 metres (300 ft.) If longer lengths are required they must be spliced or have a connector installed on them.

Environmental Limits

Operating Temperature	-40°C to +85°C (-40°F to +185°F).
Storage Temperature	-40°C to +100°C (-40°F to +212°F).
Shock Limit	5000 g pk, maximum.
Humidity Limit	100% condensing, non-submerged.
Magnetic Field Susceptibility	<0.0068 mm/s/gauss (0.268 mil/s/gauss) @ 50 gauss, 50-60Hz

Mechanical

Weight	<297 g (10.5 oz.), typical.
Mounting Surface	33 mm diameter (1.3 in diameter).
Height	82 mm (3.2 in).
Case Material	316L stainless steel
Connector	2-pin 316L stainless steel MIL-C-5015, top.
Mounting Torque	4.5 N-m \pm 0.6 N-m (40 in-lbf \pm 5 in-lbf).
Polarity	Pin A goes positive with respect to Pin B when velocity is from base to top of the transducer.
Mounting Angle	Any orientation.

For more information on this product, please refer to the Velomitor CT Piezo-Velocity Transducer User Guide (document 125389).

Compliance and Certifications

FCC

This device complies with part 15 of the FCC Rules. Operation is subject to the following two conditions:

- This device may not cause harmful interference.
- This device must accept any interference received, including interference that may cause undesired operation.

EMC

EMC Directive 2014/30/EU

RoHS

RoHS Directive 2011/65/EU

Hazardous Area Approvals



For the detailed listing of country and product specific approvals, refer to the *Approvals Quick Reference Guide* (108M1756) available from Bently.com.

CSA/NRTL/C

190501 (Agency Approval Options 01 through 04)

Intrinsically Safe	<p>Ex ia IIC T4: Class I, Div 1, Groups A, B, C, D. Class II, Group E, F and G Class III</p> <p>AEx ia IIC T4: Class I, Div 1, Groups A, B, C, D; Class II, Groups E, F, G Class III</p> <p>Install per drawing 167536</p> <p>T4 @ -40°C ≤ Ta ≤ +100°C (-40°F ≤ Ta ≤ +212°F)</p>
Intrinsically Safe and Non-Incendive	<p>Ex nL IIC T4 Class I, Division 2, Groups A, B, C and D</p> <p>AEx nA T4 Class I, Division 2, Groups A, B, C and D</p> <p>Install per drawing 167536</p> <p>T4 @ -40°C ≤ Ta ≤ +100°C (-40°F ≤ Ta ≤ +212°F)</p>

ATEX/IECEX

190501 Entity Parameters

 II 1 G

Ex ia IIC T4 Ga

 II 3 D

Ex na IIC T4 Gc

Ex tc IIIC T130°C Dc

T4@ Ta = -55°C to 121°C

Zone 0/1	Zone 2
Ui= 30V	Ui= 30V
Ii= 200mA	Ii= 200mA
Pi= 0.75W	Pi= 1.14W
Ci=27.2nF	
Li= 0	

Hazardous Area Conditions of Safe Use

ATEX/IECEX

Zone 0/1:

Equipment must be connected to equipment, which meets the abovelisted entity parameters.

The cables type A or B (in compliance with EN 60079-25) must respect the cable parameters listed with the entity parameters.

Zone 2 :

The supply electrical parameters shall not exceed the values mentioned in the tables above.

Ordering Information

Velomitor CT Velocity Transducer

190501 - AA - BB - CC

A: Mounting Hardware Option

0 0	No stud
0 1	Stud 3/8-in 24 to 3/8-in 24
0 2	Stud 3/8-in 24 to 1/2-in 20
0 3	Adhesive Stud 3/8-in 24
0 4	Stud M6x1 with 3/8-in 24 adapter
0 5	Adhesive Stud M6x1 with 3/8-24 adapter
0 6	Stud 3/8-in 24 to 1/4-in 28
0 7	Plate Stud 3/8-in 24 to 3/8-in 24
0 8	Plate Stud 3/8-in 24 to 1/2-in 20
0 9	Plate Stud 3/8-in 24 to 1/4-in NPT
1 0	Plate Stud M6x1 to M6x1with 3/8-in 24 adapter
1 1	Plate Stud 3/8-in 24 to 1/4-in 28
1 2	Plate Stud 3/8-in 24 to M8x1
1 3	Quick disconnect stud
1 4	Adapter, 3/8-in 24 to 1/4-in 20
1 5	Adapter, 3/8-in 24 to 5/16-in 18
1 6	Adapter, 3/8-in 24 to 3/8-in 24
1 7	Adapter, 3/8-in 24 to 3/8-in 16
1 8	Adapter, 3/8-in 24 to 1/2-in 13
1 9	Adapter, 3/8-in 24 to 1/4-in 18 NPT
2 0	Adapter, 3/8-in 24 to 3/8-in 18 NPT
2 1	Adapter, 3/8-in 24 to 1/2-in 14

	NPT
2 2	Adapter, 3/8-in 24 to 3/4-in 14 NPT
2 3	Adapter, 3/8-in 24 to 1.0-in 11.5 NPT
2 4	Adapter, 3/8-in 24 to 1.25-in 11.5 NPT

B: Connection Option

0 0	MIL-C-5015 connection interface
9 9	Unit with included 32-foot cable

C: Agency Approval Option

0 0	No Approvals
0 1 through 0 4	CSA/NRTL/C (Class I, Division 1), ATEX/IECEX/CSA (Class I, Zone 0/1)

Interconnect Cable

CB2W100 - AAA

Description: Connectors: MIL-C 5015, 2 Socket, Splash Proof, Premium, isolated to blunt cut, Cable: 20 AWG, twisted pair, shielded, yellow Teflon jacket. LOCKING RING, ADAPTER SEAL, AND O-RING ARE INCLUDED.

A: Length

0 1 5	15 feet (4.57 metres)
0 3 2	32 feet (9.75 metres)
0 6 4	64 feet (19.5 metres)
1 1 2	112 feet (34.1 metres)
1 2 5	125 feet (38.1 metres)
1 5 0	150 feet (45.7 metres)
2 0 0	200 feet (61.0 metres)
2 5 0	250 feet (76.2 metres)

Accessories

128608-02	1/2-in NPT conduit adapter
04284020-01	Adhesive mount base kit. The adhesive mount base kit design is for machines with thin casings that do not permit drilling and tapping a mounting hole. Kit contains material (adhesive and bases) for 2 each 3/8-in 24 UNF adhesive-mount bases. One kit can outfit 2 Velomitor CT Transducers.

Spare Mounting Adapters

All mounting adapters are made from 300 series stainless steel.

Standard Studs

04365657	3/8-in 24 to 3/8-in 24 stud
87910-01	3/8-in 24 to 1/2-in 20 stud
87931-01	M6x1 to M6x1 metric stud (requires metric adapter)
87055-01	3/8-in 24 to M6x1 metric adapter
89139-01	3/8-in 24 to 1/4-in 28 stud

Hex Plate Studs

107756-01	3/8-in 24 to 3/8-in 24 plate stud
107755-01	3/8-in 24 to 1/2-in 20 plate stud
107754-01	3/8-in 24 to 1/4-in NPT plate stud
107757-01	M6x1 to M6x1 plate stud (requires metric adapter)
125094-01	3/8-in 24 to M8x1 metric plate stud
128038-01	3/8-in 24 to 1/4-in 28 Plate Stud

Quick Disconnect Components

The following three components are included with the quick disconnect mounting option for the Velomitor CT Transducer. The quick disconnect option allows you to remove the transducer without rotating it, allowing you to keep the cable connected to the transducer.

128689-01	3/8-in 24 to 1¼-in 16 quick disconnect stud base. Attached to the machine.
43055-01	1¼-in 16 mounting base nut. Interface between stud base and transducer piece.
128690-01	3/8-in 24 quick disconnect stud transducer piece. Attached to the Velomitor CT Transducer.

Fittings

Conduit fittings allow connection of flexible, metal, liquid-tight conduit or armor to the conduit adapter.

03839201	1/2-in NPT straight male conduit fitting. For connecting flexible, liquid-tight conduit to the conduit adapter or a weatherproof enclosure.
03850000	1/2-in NPT straight, male compression-type fitting. For connecting Teflon™-coated 3/8-in stainless steel armor to the transducer or a weatherproof enclosure. Fitting will fit Teflon™-coated armor with a maximum outer diameter of 13.8 mm (0.543 in) (including Teflon™ thickness).

Teflon-Coated Stainless Steel Armor

106924-AA



This part includes the Teflon-coated armor but not the cable. You will require 2 1/2-in NPT compression fittings (part number 03850000) to attach the armor to the conduit adapter and terminate it at an enclosure.

A: Armor Length Option in Feet

Order in increments of 10 ft (3.0 m)

Minimum Length: 10 ft (3.0 m)

Maximum Length: 60 ft (18.3 m)

Flexible Metal Conduit

14847-AA

A: Flexible Conduit Length Option in Feet

Order in increments of 1 ft (0.3 m)

Minimum Length: 01 ft (0.3 m)

Maximum Length: 99 ft (30.2 m)

106769-01

Terminal housing. Provides a convenient interface between the transducer signal cable and monitor signal cable.

Graphs and Figures

Note: All dimensions shown are in millimeters (inches) unless noted otherwise.

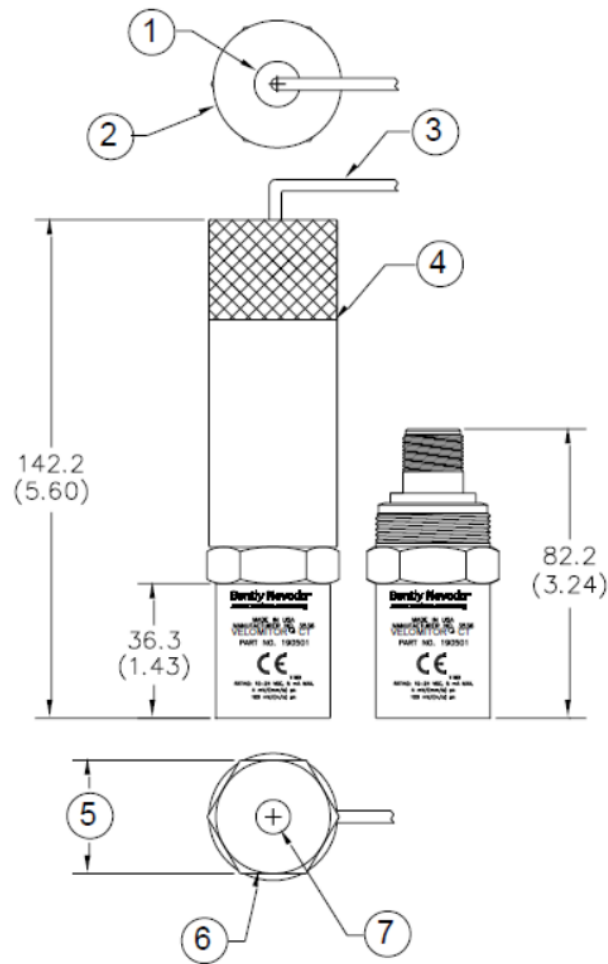

1. 1/2" NPT x 12.2 DP (1/2" NPT x 0.48 DP)
2. 35.6 (1.40) diameter
3. Cable (not included)
4. Conduit adaptor P/N 128608-02 (not included)
5. 31.8 (1.25) hex flat
6. 31.5 (1.24) diameter
7. 3/8-24 UNF X 8.9 DP (3/8-24 UNF X 0.35 DP)

Figure 1: Velomitor CT Outline Drawing

Spare Mounting Adapters



All mounting adapters are made from 300 series stainless steel. Illustrations shown are not to scale.

Table 1: Standard Studs



Part Number	Size	Illustration
04365657	3/8-24 to 3/8-24	
87055-01	3/8-24 to M6X1	
87910-01	3/8-24 to 1/2-20	
87931-01	M6X1 to M6X1	
89139-01	3/8-24 to 1/4-28	

Table 2: Adhesive Studs

Part Number	Size	Illustration
04284020	3/8-24	

Table 3: 1-3/8 Hex Plate Studs

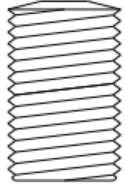
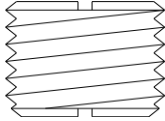
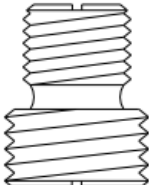
Part Number	Size	Illustration
107754-01	3/8-24 UNF to 1/4 NPT	
107755-01	3/8-24 UNF to 1/2-20 UNF	
107756-01	3/8-24 to 3/8-24	
107757-01	M6X1 to M6X1	
125094-01	3/8-24 UNF to M8X1	
128038-01	3/8-24 UNF to 1/4-28 UNF	

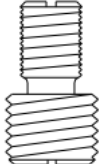
Table 4: Quick Disconnect Studs

Part Number	Description	Illustration
43055-01	Union Mounting Base Nut	

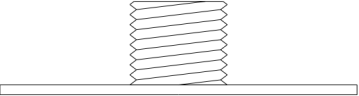
Part Number	Description	Illustration
128689-01	Quick Disconnect Stud Base	
128690-01	Quick Disconnect Transducer Piece	

Graphs

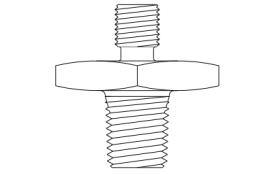
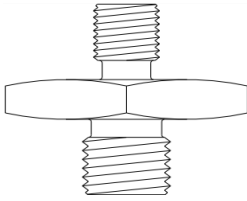
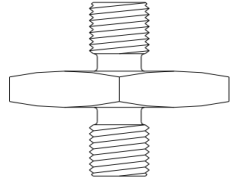
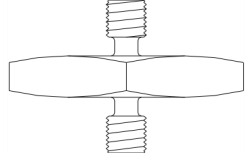
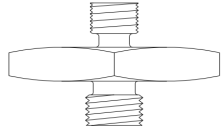
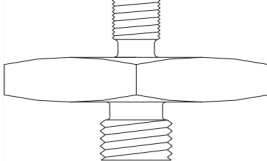
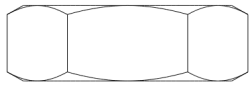
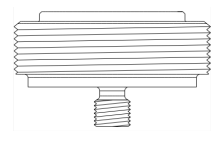
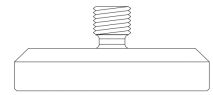
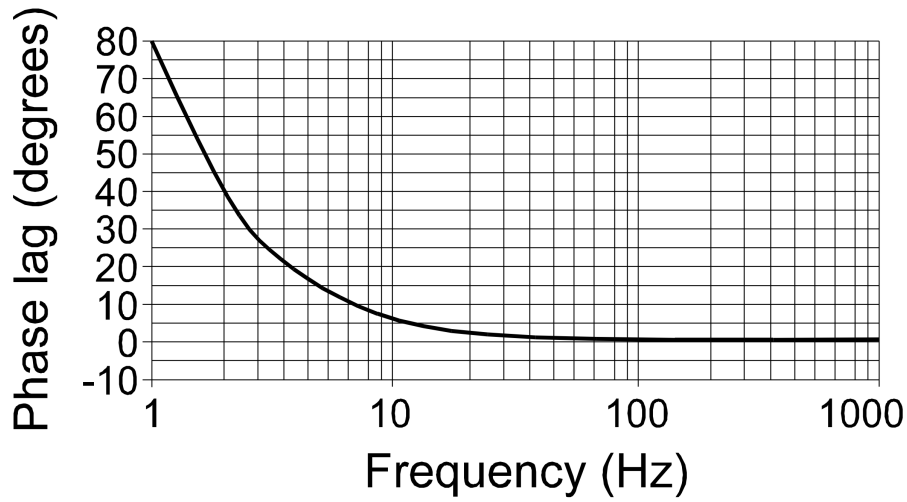

Figure 2: Typical Phase Response

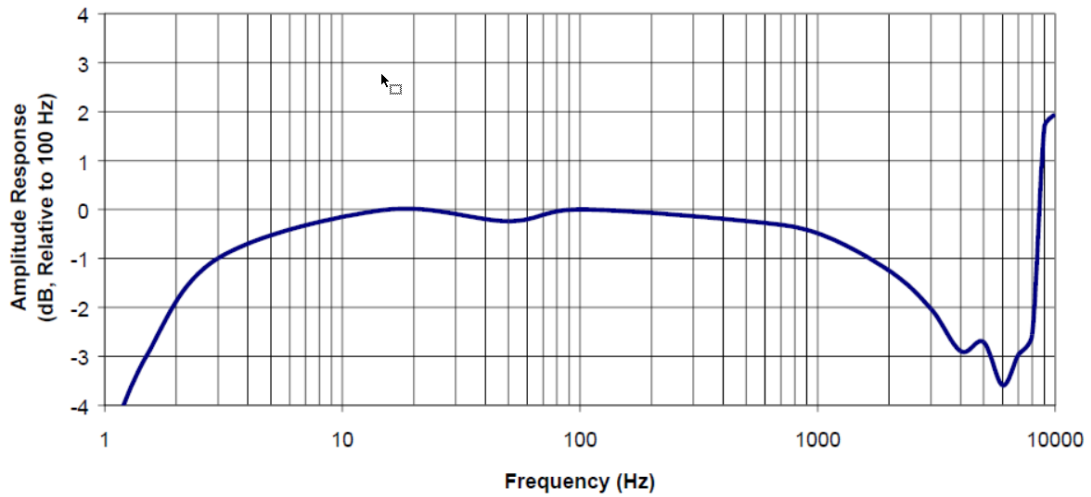
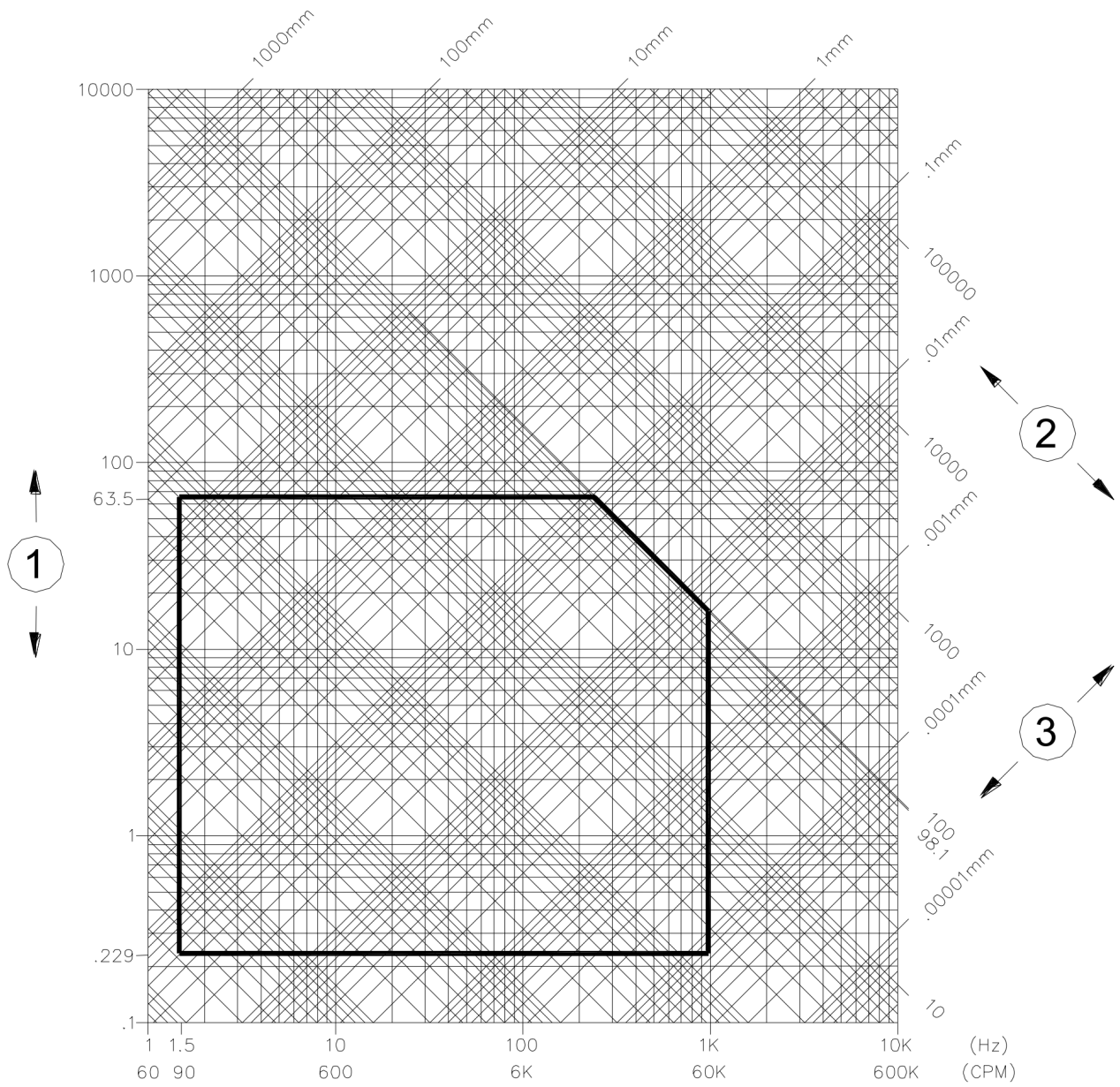
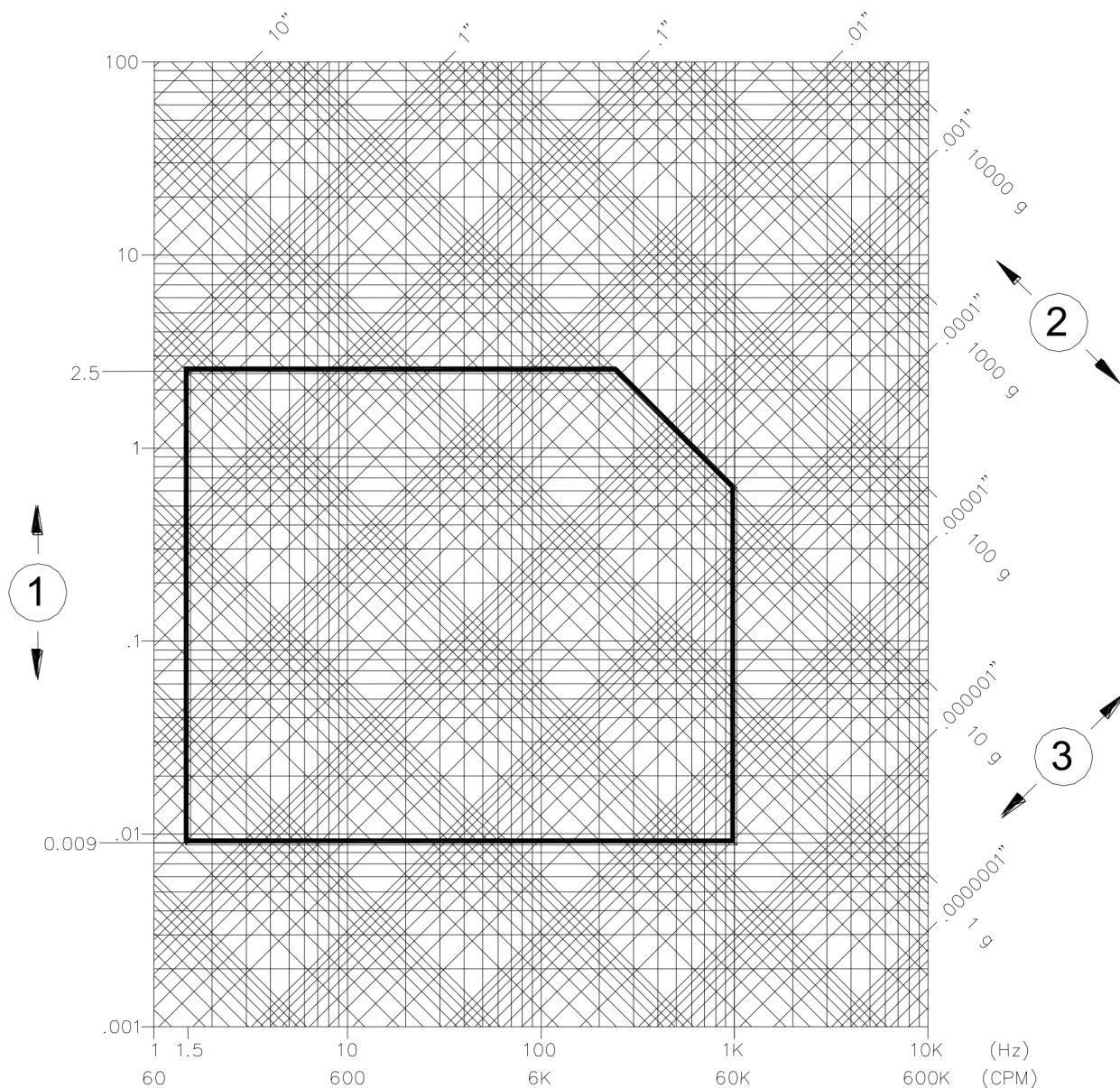

Figure 3: Typical Amplitude Response



1. Velocity axis (mm/s peak-peak)
2. Displacement axis (mm peak-peak)
3. Acceleration axis (m/s² peak-peak)

Figure 4: Operating Range for Metric Units



1. Velocity axis (in./s peak-peak)
2. Displacement axis (in. peak-peak)
3. Acceleration axis (g peak-peak)

Figure 5: Operating Range for English Units

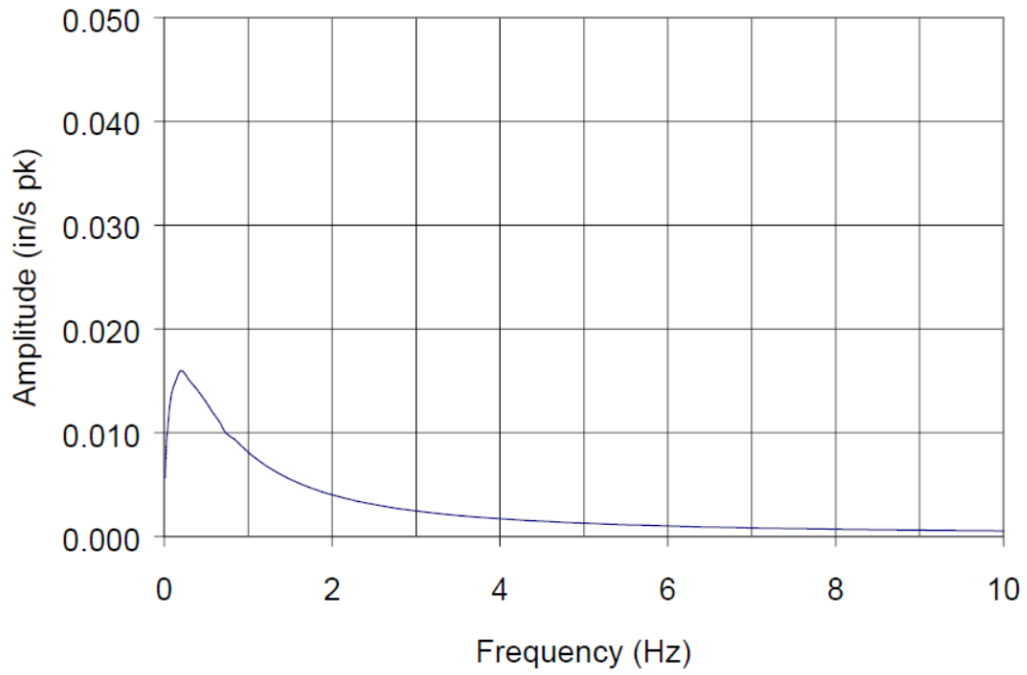

Figure 6: Typical Low Frequency Noise Floor

Copyright 2021 Baker Hughes Company. All rights reserved.



Bently Nevada, Adapt, Velomitor and Orbit Logo are registered trademarks of Bently Nevada, a Baker Hughes Business, in the United States and other countries. The Baker Hughes logo is a trademark of Baker Hughes Company. All other product and company names are trademarks of their respective holders. Use of the trademarks does not imply any affiliation with or endorsement by the respective holders.

Baker Hughes provides this information on an "as is" basis for general information purposes. Baker Hughes does not make any representation as to the accuracy or completeness of the information and makes no warranties of any kind, specific, implied or oral, to the fullest extent permissible by law, including those of merchantability and fitness for a particular purpose or use. Baker Hughes hereby disclaims any and all liability for any direct, indirect, consequential or special damages, claims for lost profits, or third party claims arising from the use of the information, whether a claim is asserted in contract, tort, or otherwise. Baker Hughes reserves the right to make changes in specifications and features shown herein, or discontinue the product described at any time without notice or obligation. Contact your Baker Hughes representative for the most current information.

The information contained in this document is the property of Baker Hughes and its affiliates; and is subject to change without prior notice. It is being supplied as a service to our customers and may not be altered or its content repackaged without the express written consent of Baker Hughes. This product or associated products may be covered by one or more patents. See [Bently.com/legal](https://www.bently.com/legal).

1631 Bently Parkway South, Minden, Nevada USA 89423
Phone: 1.775.782.3611 (US) or [Bently.com/support](https://www.bently.com/support)
[Bently.com](https://www.bently.com)