

# Coreline

## Pneumatic actuators



English

**Fig.540 : Air/Air**

**Fig.541 : Air/Spring**



[www.coreline.dk](http://www.coreline.dk)

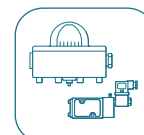
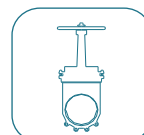
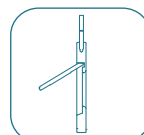
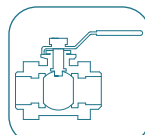
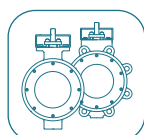
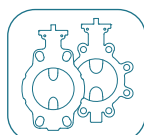

# General specifications

## Specifications

The Coreline Fig.540/541 pneumatic actuators, have been designed and tested to obtain the highest cycling life and the most reliable performance with minimum maintenance and service. Specifications of Coreline pneumatic actuators follow international standards convenient for faster mounting. CE approval and ATEX certification provide guarantee for safety and reliability. A wide product range, permits a more economical sizing.



Operating media:	Dry or lubricated air, non-corrosive gas
Operating temperature:	-20°C~+80°C : Standard (NBR O-ring) -40°C~+80°C : Low temperature (Silicone O-ring) -20°C~+150°C : High temperature (FPM O-ring)
Travel adjustment:	Adjustable +4°/-4° by 0° and 90° position
Air supply pressure:	2.5bar~8bar
Lubrication:	Pre-lubricated for life of actuator on assembly under normal operating conditions



ATEX, CE and SIL approval for all Coreline pneumatic actuators.

## Index

page 3	Design features
page 4	Part list and material specification
page 5	Dimensions
page 6	Operating principle
page 7	Double acting - Sizing and output torque
page 8	Spring return - Sizing
page 9-11	Spring return - Output torque
page 12	Actuator interface for valve automation
page 13	Technical data
page 14	Pneumatic accessories
page 15-16	Installation guide

# Design features

## Design features

### Visual indicator prepared for inductive sensor

Position indicator makes it easy to see position of valve and protect turning point against dirt and ambient. Fastened by stainless steel screw/washer. Built-in signal generator, prepared for inductive sensor.

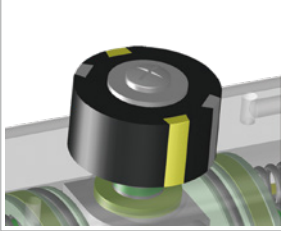

### Polished actuator body

Standard body in hard anodised aluminium (40 µ) and polished for better corrosion resistance and less friction on internal parts for better performance. Epoxy&polyester painting, PTFE or nickel plated body as option.

### Pistons with patent

Twin rack pistons made from hard anodized die-casting aluminum. Balanced rack and pinion with full width pinion/piston engagement. Patent reinforced support on each side of teeth, provide strong solution with long cycle life and fast operation, with linear torque curve.

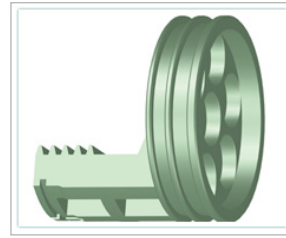

### Bearings and guides

Made from low friction, long-life composite material, provide maximum protection against wear. The maintenance and replacement are easy and convenient.

### End caps

Die-casting aluminum, powder polyester painted. PTFE or nickel plated as option.

### O-rings

NBR O-rings provide trouble-free operation as standard. By high or low temperature, FPM or Silicone are optional.

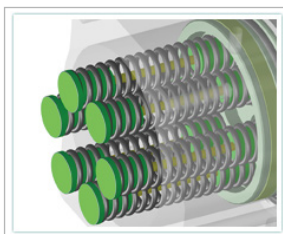

### Preloaded springs

High performance springs in Fig.541: Single acting. Coated springs for corrosion resistance and preloaded for safe maintenance.

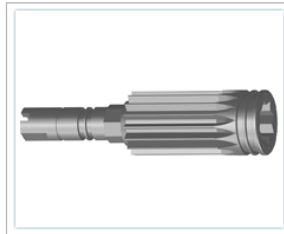

### Pinion

High-precision pinion made from nickel alloy steel and with full width pinion/piston engagement for greater operational life.

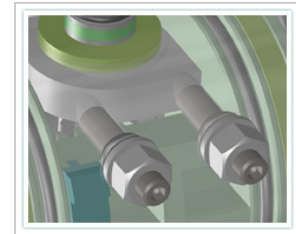

### Travel adjustment

The two independent travel stop adjustment bolts can adjust  $\pm 4^\circ$  at both open and close directions, easily and precisely. Stop cam is made by bar material, which with better strength than normal casting, which usually is standard for actuators.

## Part list and material specification

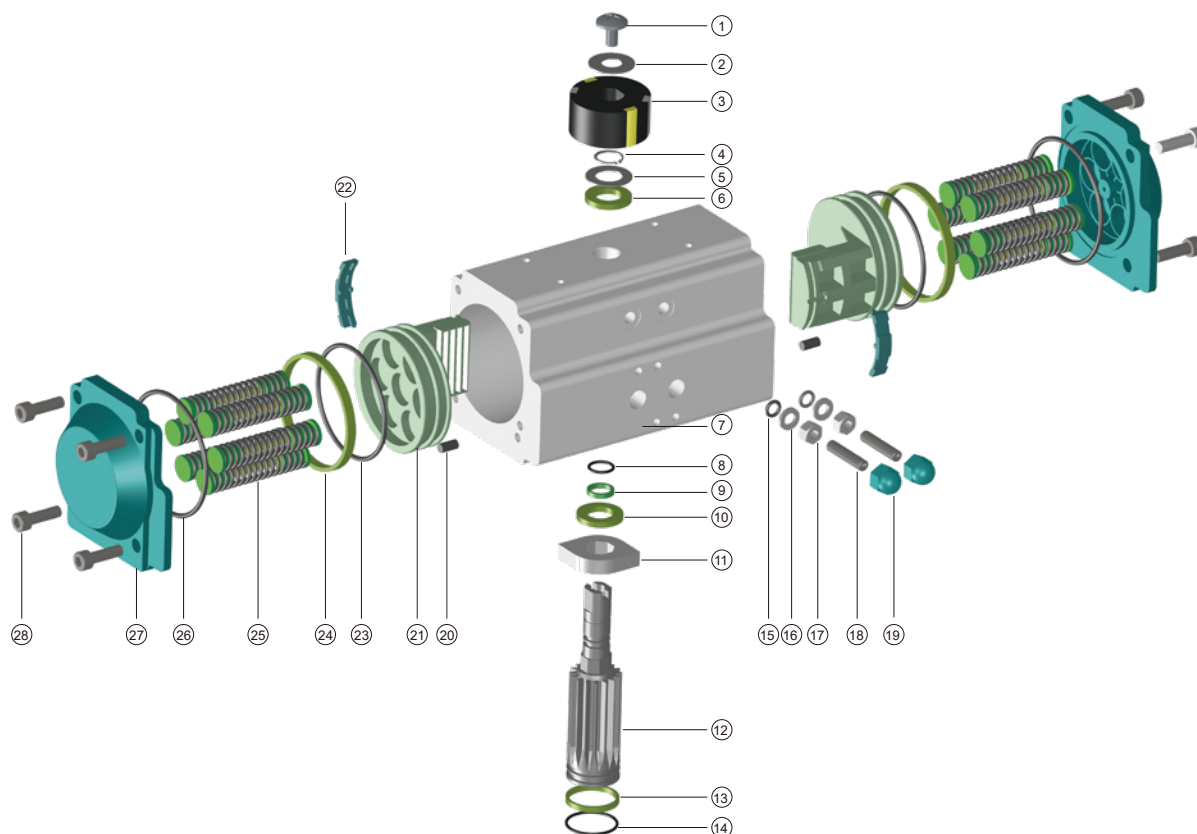

No.	Part name	Qty	Standard material	Protection	Optional material
1	Cap screw (Indicator)	1	Stainless steel(304)		
2	Washer (Indicator)	1	Stainless steel(304)		
3	Position indicator	1	Polyoxymethylene		
4	Spring clip (Pinion)	1	Stainless steel(304)		
5	Thrust washer	1	Stainless steel(304)		
6	Thrust bearing (Pinion)	1	Polyoxymethylene		
7	Body	1	Extruded aluminum alloy(6005-T5)	Hard anodized and polished *	
8	O-ring (Pinion top)	1	NBR		FPM/Silicone
9	Bearing (Pinion top)	1	Polyoxymethylene		
10	Thrust bearing (Pinion)	1	Polyoxymethylene		
11	OCTI Cam (Stop arrangement)	1	Alloy steel(45#)		
12	Pinion	1	Alloy steel(45#)	Nickel plated	Stainless steel
13	Bearing (Pinion bottom)	1	Polyoxymethylene		
14	O-ring (Pinion bottom)	1	NBR		FPM/Silicone
15	O-ring (Adjust screw)	2	NBR		FPM/Silicone
16	Washer (Adjust screw)	2	Stainless steel(304)		
17	Nut (Adjust screw)	2	Stainless steel(304)		
18	Adjust screw	2	Stainless steel(304)		
19	Nut cover (Adjust screw)	2	Plastic (ABS)		
20	Plug	2	NBR		FPM/Silicone
21	Piston	2	Cast aluminum/casting(101A)	Anodized	Stainless steel
22	Plate (Piston)	2	Polyoxymethylene		
23	O-ring (Piston)	2	NBR		FPM/Silicone
24	Bearing (Piston)	2	Polyoxymethylene		
25	Spring	0~12	Spring steel	Dip coating	
26	O-ring (End cap)	2	NBR		FPM/Silicone
27	End cap	2	Cast aluminum(ADC12)	Powder polyester painted etc	
28	Cap screw	8	Stainless steel(304)		

\* PTFE or Nickel plated.

# Dimensions

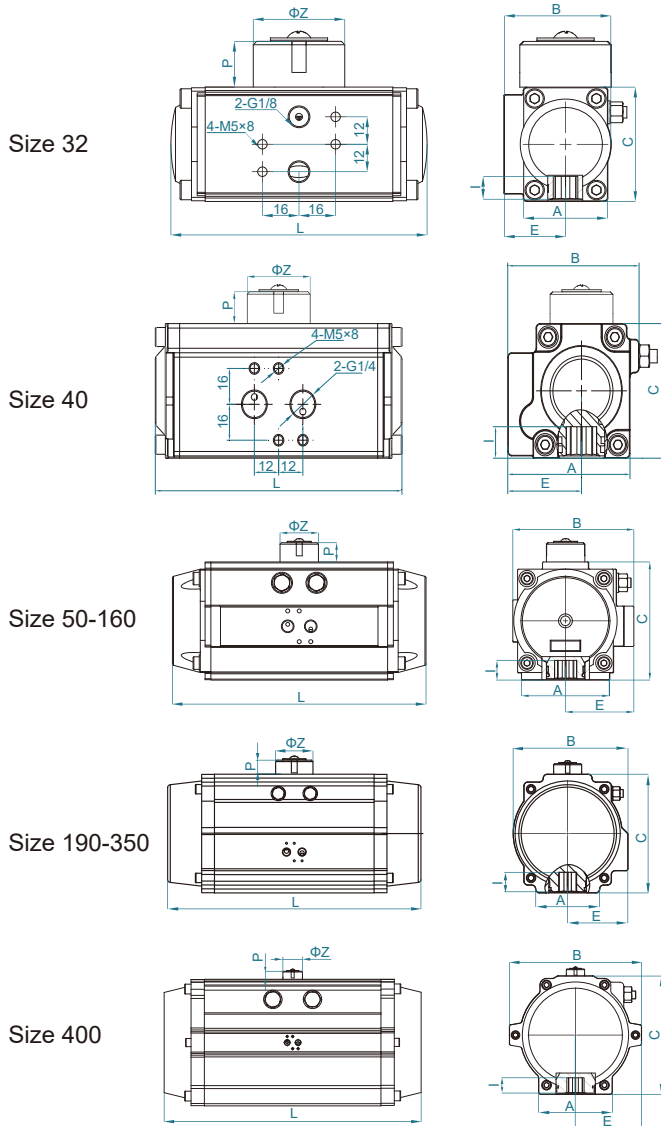

## VDI/VDE 3845 Top connection

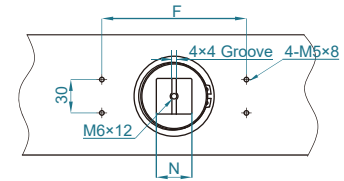

## NAMUR air connection

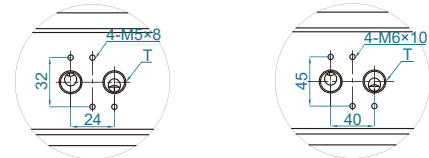

G1/4" : Size 40-210

G1/2" : Size 240-400

## ISO5211 - DIN3337 Bottom view

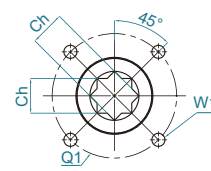

Size 32, 210-300

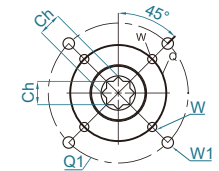

Size 40-190

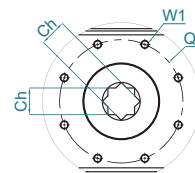

Size 400

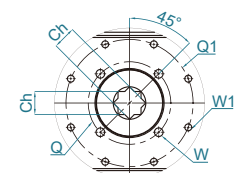

Size 350

Size	A	B	C	L	E	F	P	ΦZ	N	Double acting		Spring return		ISO5211	Q	Q1	W	W1	Air interface
										Ch	I	Ch	I						
* 32	37	47	50	110	27	50	20	40	10	9x9	11	-	-	F03, F04	-	36	-	M5x9	G1/8"
40	60	65	60	144	36.5	50/80	20	40	10	9x9,11x11	13	9x9	11	F03+F05,F04	36	50	M5x8	M6x9	G1/4"
50	45	70.5	70	154	41.5	80	20	40	10	9x9,11x11	13	9x9,11x11	11	F03+F05,F04	36	50	M5x8	M6x9	G1/4"
65	62	89.5	89	189	51.5	80	20	40	10	14x14	16	11x11	13	F03+F05,F04	36	50	M5x8	M6x9	G1/4"
75	68	102.5	100	210	59	80	20	40	14	14x14	16	14x14	16	F05+F07	50	70	M6x9	M8x12	G1/4"
85	68	112.5	113	229	63.5	80	20	40	14	17x17	19	14x14	16	F05+F07	50	70	M6x9	M8x12	G1/4"
95	92	126	123	264	71	80	20	40	14	17x17	19	14x14	16	F05+F07	50	70	M6x9	M8x12	G1/4"
110	93	138.5	136	266	76.5	80	20	40	14	17x17	19	14x14	16	F07+F10	70	102	M8x12	M10x15	G1/4"
125	96	157	161	337	85	80	30	56	22	22x22	25	17x17	19	F07+F10	70	102	M8x12	M10x15	G1/4"
140	110	178	178	377	97	80/130	30	56	22	27x27	31	17x17	19	F10+F12	102	125	M10x15	M12x18	G1/4"
160	112	196	200	412	106	80/130	30	56	22	27x27	31	22x22	25	F10+F12	102	125	M10x15	M12x18	G1/4"
190	136	216.5	232	488	112	130	30	56	22	27x27	31	27x27	31	F10+F14,F12	102	140	M10x15	M16x24	G1/4"
210	140	235.5	255	550	120	130	30	80	32	36x36	40	27x27	31	F14	-	140	-	M16x24	G1/4"
240	159	262	292	602	131	130	30	80	32	46x46	50	27x27	31	F14,F16	-	165	-	M20x28	G1/2"
270	159	295	331	672	147.5	130	30	80	32	46x46	50	36x36	40	F16	-	165	-	M20x28	G1/2"
300	180	335	354	784	173	130	30	80	32	46x46	50	46x46	50	F16	-	165	-	M20x28	G1/2"
350	270	385	410	845	195	130	30	80	32	46x46	50	46x46	50	F16+F25	165	254	M20x28	M16x30	G1/2"
400	290	520	466	956	260	130	30	80	32	46x46	50	46x46	50	F25	-	254	-	M16x30	G1/2"

\* Size 32 is only available for double acting type.

# Operating principle

## Principle of double acting actuators

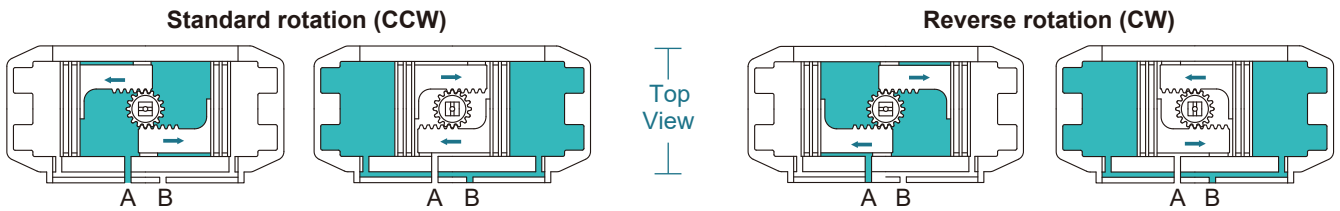

Air to Port A forces the pistons outwards, causing the pinion to turn counterclockwise while the air is being exhausted from Port B.

Air to Port B forces the pistons inwards, causing the pinion to turn clockwise while the air is being exhausted from Port A.

Air to Port A forces the pistons outwards, causing the pinion to turn clockwise while the air is being exhausted from Port B.

Air to Port B forces the pistons inwards, causing the pinion to turn counterclockwise while the air is being exhausted from Port A.

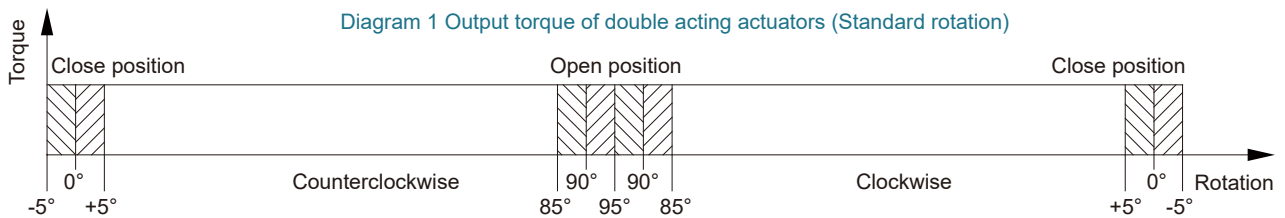

With reference to diagram 1, it can be noticed that the double acting pneumatic actuator has constant torque over the whole stroke.

## Principle of spring return actuators

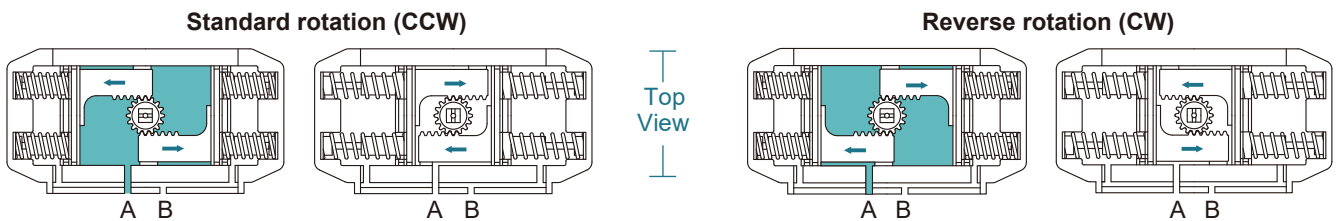

Air to port A forces the pistons outwards, causing the springs to compress. The pinion turns counterclockwise while air is being exhausted from port B.

Loss of air pressure on port A, the stored energy in the springs forces the pistons inwards. The pinion turns clockwise while air is being exhausted from port A.

Air to port B forces the pistons outwards, causing the springs to compress. The pinion turns counterclockwise while air is being exhausted from port B.

Loss of air pressure on port A, the stored energy in the springs forces the pistons inwards. The pinion turns clockwise while air is being exhausted from port A.

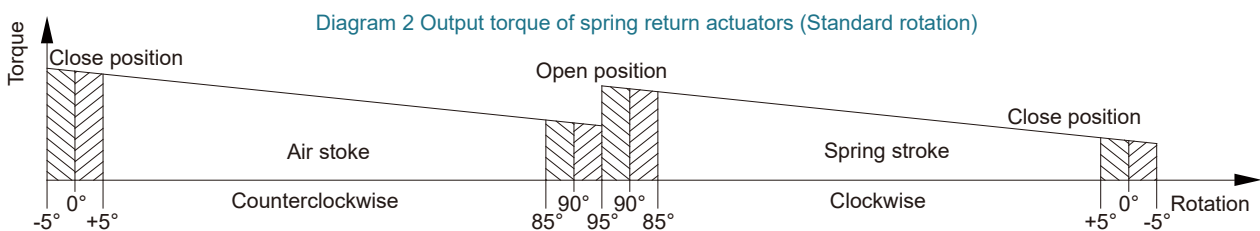

With reference to diagram 2, we can see that the output torque of spring return actuator is not constant but decreasing. This is because of the acting of springs that when compressed during air stroke counteract the piston movement and accumulate energy which will be available in a decreasing way during the rotation inversion.



# Double acting - Sizing and output torque

## Sizing - Double acting actuators

Double acting actuator has constant torque over the whole stroke, follow the below instructions to choose the actuator model for correct sizing.

- Define the maximum torque of the valve.
- Multiply the valve torque with a safety factor according to the valve manufacturer advice. Safety factor depends on the valve type and working conditions.
- Look at the column below the actual air supply pressure to find a torque value exact to or exceeding the torque needed.
- Once the torque value is found, move to the left column "Size" to find the required actuator model.

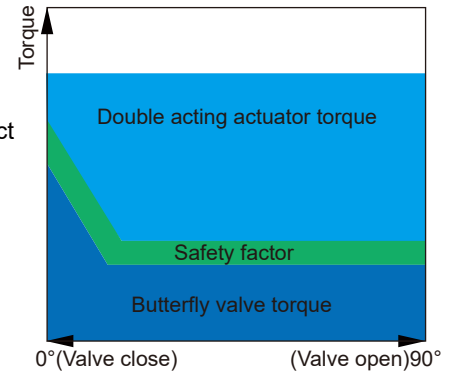

## Sizing example - Double acting actuators

Butterfly valve torque including safety factor: = 67.6Nm (52Nm + 30% safety)

Air supply pressure: = 5bar

**Size 85** produces a minimum output torque of 82.8Nm

Ball valve torque including safety factor: = 728Nm (560Nm + 30% safety)

Air supply pressure: = 7bar

**Size 160** produces a minimum output torque of 785Nm

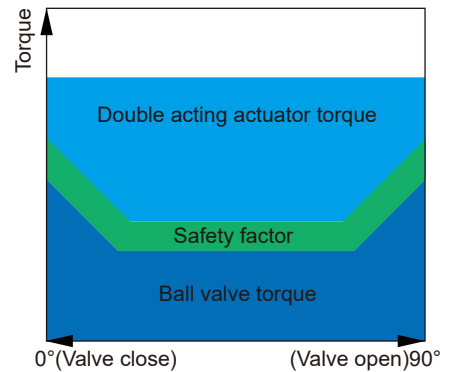

## Output torque of double acting actuators

Size	Air supply pressure (bar)									
	2.5	3	3.5	4	4.5	5	5.5	6	7	8
	Output torque of double acting (Nm)									
32	2.9	3.4	4.0	4.6	5.3	5.9	6.5	7.1	8.3	9.5
40	5.7	6.9	8.1	9.4	10.6	11.8	13.0	14.3	16.7	19.2
50	8.6	10.4	12.3	14.2	16.0	17.9	19.8	21.6	25.4	29.1
65	17.4	21.2	25.0	28.7	32.5	36.3	40.1	43.9	51.4	59.0
75	27.0	32.9	38.8	44.7	50.5	56.4	62.3	68.2	79.9	91.7
85	39.7	48.3	56.9	65.6	74.2	82.8	91.4	100.1	117.3	134.6
95	55.7	67.9	80.0	92.1	104.2	116.4	128.5	140.6	164.8	189.1
110	72.0	89.3	105.0	120.6	136.3	152.0	167.6	183.3	214.6	245.9
125	128.7	159.5	187.5	215.4	243.4	271.4	299.4	327.4	383.3	439.3
140	196.4	237.4	278.3	319.2	360.2	401.1	442.0	482.9	564.8	646.6
160	263.5	326.6	383.9	441.2	498.5	555.8	613.1	670.4	785.0	899.7
190	428.5	518.0	607.3	696.6	785.9	875.3	964.6	1053.9	1232.5	1411.1
210	598.2	723.2	847.9	972.6	1097.3	1222.0	1346.6	1471.3	1720.7	1970.1
240	953.8	1121.7	1315.1	1508.5	1701.9	1895.3	2088.7	2282.1	2668.9	3055.7
270	1304.8	1576.6	1848.4	2120.2	2392.1	2663.9	2935.7	3207.5	3751.2	4294.8
300	1678.6	2029.4	2379.3	2729.2	3079.1	3429.0	3778.9	4128.8	4828.5	5528.3
350	2492.5	3011.8	3531.1	4050.4	4569.6	5088.9	5608.2	6127.5	7166.0	8204.6
400	3798.1	4589.4	5380.7	6172.0	6963.3	7754.5	8545.8	9337.1	10919.7	12502.2

# Spring return - Sizing

## Sizing - Spring return actuators

Spring return actuator has four different torque values: Air torques at 0° and 90° when pressurized. Spring torques at 90° and 0° when air pressure is discharged. Follow the below instructions to choose the actuator model for correct sizing.

- Define the maximum torque of the valve.
- Multiply the valve torque with a safety factor according to the valve manufacturer advice. Safety factor depends on the valve type and working conditions.
- Look at the column below the actual air supply pressure and column for spring torque and find a size where both torque values are exact to or exceeding the torque needed. It is the lowest torque value which counts for both air and spring torque. Note there is different torque development for ball valves and butterfly valves.
- Once the torque value is found, move to the left column "Size" to find the required actuator model.

## Sizing example - Spring return actuators

**OBS:** Butterfly valve torque is 100% by 0° to 6° angle and 33% from 7° to 90° angle.

Butterfly valve torque including safety factor: = 67.6Nm (52Nm + 30% safety)

Torque by 0° to 6°: = 67.6Nm

Torque by 7° to 90°: = 22.3Nm

Air supply pressure: = 5bar

**Size 110 S12** produces minimum required torque as follows:

Air stroke 0°: = 83.3Nm > 67.6Nm

Air stroke 90°: = 41.9Nm > 22.3Nm

Spring stroke 90°: = 110Nm > 22.3Nm

Spring stroke 0°: = 68.6Nm > 67.6Nm

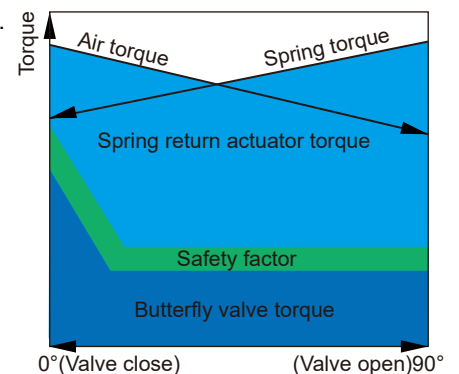

Ball valve torque including safety factor: = 728Nm (560Nm + 30% safety)

Air supply pressure: = 7bar

**Size 240 S9** produces minimum required torque as follows:

Air stroke 0°: = 1930.0Nm > 728Nm

Air stroke 90°: = 1671.7Nm > 728Nm

Spring stroke 90°: = 997.2Nm > 728Nm

Spring stroke 0°: = 738.9Nm > 728Nm

**Size 240 S12** produces minimum required torque as follows:

Air stroke 0°: = 1683.7Nm > 728Nm

Air stroke 90°: = 1339.3Nm > 728Nm

Spring stroke 90°: = 1329.6Nm > 728Nm

Spring stroke 0°: = 985.2Nm > 728Nm

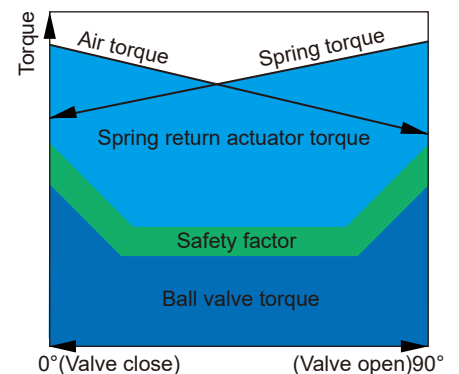



# Spring return - Spring set configuration and output torque

## Spring set configuration

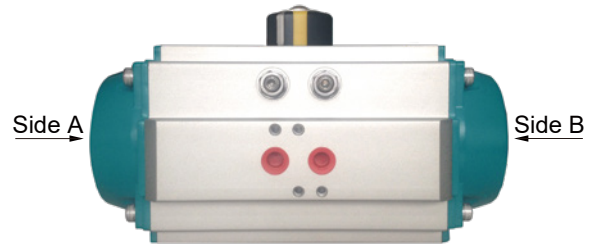
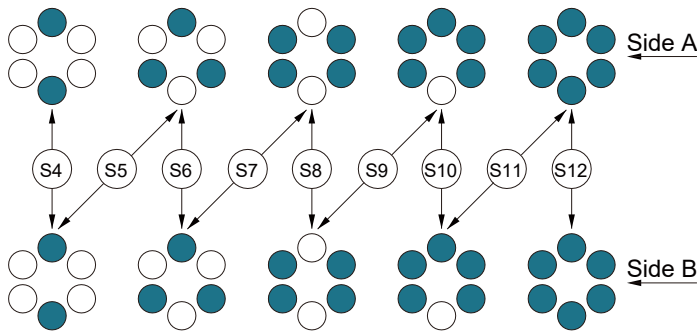

## Output torque of spring return actuators

Size	Spring qty	Spring torque (Nm)		Air supply pressure (bar)																					
				2.5		3		3.5		4		4.5		5		5.5		6		7		8			
				90°	0°	0°	90°	0°	90°	0°	90°	0°	90°	0°	90°	0°	90°	0°	90°	0°	90°	0°	90°	0°	
40	4	5.6	3.8					4.3	2.5	5.5	3.7	6.7	4.9	8.0	6.2	9.2	7.4	10.4	8.6	12.9	11.1	15.4	13.6		
	5	7.1	4.7							4.6	2.3	5.9	3.5	7.1	4.7	8.3	6.0	9.6	7.2	12.0	9.7	14.5	12.1		
	6	8.6	5.7									4.9	2.0	6.1	3.2	7.3	4.5	8.6	5.7	11.0	8.2	13.5	10.6		
50	5	5.2	3.5	5.1	3.4	6.9	5.3	8.8	7.2	10.7	9.0	12.5	10.9	14.4	12.8										
	6	6.2	4.2	4.4	2.4	6.2	4.3	8.1	6.1	10.0	8.0	11.8	9.9	13.7	11.7	15.6	13.6								
	7	7.2	4.9			5.5	3.2	7.4	5.1	9.3	7.0	11.1	8.8	13.0	10.7	14.9	12.6	16.7	14.4						
	8	8.2	5.6					6.7	4.1	8.6	5.9	10.4	7.8	12.3	9.7	14.2	11.5	16.0	13.4	19.8	17.1				
	9	9.3	6.3							7.9	4.9	9.7	6.8	11.6	8.6	13.5	10.5	15.3	12.4	19.1	16.1	22.8	19.8		
	10	10.3	7.0							7.2	3.9	9.0	5.7	10.9	7.6	12.8	9.5	14.6	11.3	18.4	15.1	22.1	18.8		
	11	11.3	7.7							6.5	2.8	8.3	4.7	10.2	6.6	12.1	8.4	13.9	10.3	17.7	14.0	21.4	17.8		
65	4	10.5	7.0	10.4	6.9	14.2	10.7	18.0	14.5	21.8	18.3	25.6	22.1												
	5	13.1	8.7	8.7	4.3	12.5	8.1	16.3	11.9	20.0	15.6	23.8	19.4	27.6	23.2										
	6	15.7	10.4	7.0	1.7	10.7	5.5	14.5	9.2	18.3	13.0	22.1	16.8	25.9	20.6	29.7	24.4								
	7	18.3	12.2			9.0	2.8	12.8	6.6	16.6	10.4	20.4	14.2	24.1	18.0	27.9	21.8	31.7	25.5						
	8	21.0	13.9					11.0	4.0	14.8	7.8	18.6	11.6	22.4	15.4	26.2	19.1	30.0	22.9	37.5	30.5				
	9	23.6	15.7							13.1	5.2	16.9	9.0	20.7	12.7	24.4	16.5	28.2	20.3	35.8	27.9	43.4	35.4		
	10	26.2	17.4							11.3	2.5	15.1	6.3	18.9	10.1	22.7	13.9	26.5	17.7	34.0	25.2	41.6	32.8		
	11	28.8	19.1							9.6	-0.1	13.4	3.7	17.2	7.5	21.0	11.3	24.7	15.1	32.3	22.6	39.9	30.2		
75	5	16.9	10.7	10.2	16.3	22.2	22.2	28.1	21.9	34.0	27.8	39.8	33.7	45.7	39.6										
	6	20.2	12.8	6.8	14.2	20.1	20.1	25.9	18.6	31.8	24.4	37.7	30.3	43.6	36.2	49.4	42.1								
	7	23.6	15.0			17.9	17.9	23.8	15.2	29.7	21.1	35.6	26.9	41.4	32.8	47.3	38.7	53.2	44.6						
	8	27.0	17.1					21.7	11.8	27.5	17.7	33.4	23.6	39.3	29.4	45.2	35.3	51.0	41.2	62.8	53.0				
	9	30.3	19.3							25.4	14.3	31.3	20.2	37.1	26.1	43.0	32.0	48.9	37.8	60.7	49.6	72.4	61.3		
	10	33.7	21.4							23.3	11.0	29.1	16.8	35.0	22.7	40.9	28.6	46.8	34.5	58.5	46.2	70.3	58.0		
	11	37.1	23.5							21.1	7.6	27.0	13.5	32.9	19.3	38.7	25.2	44.6	31.1	56.4	42.8	68.1	54.6		
	12	40.4	25.7							19.0	4.2	24.9	10.1	30.7	16.0	36.6	21.8	42.5	27.7	54.2	39.5	66.0	51.2		
85	5	26.1	16.6	23.2	13.7	31.8	22.3	40.4	30.9	49.0	39.5	57.6	48.1	66.3	56.8										
	6	31.3	19.9	19.8	8.4	28.4	17.0	37.1	25.7	45.7	34.3	54.3	42.9	62.9	51.5	71.6	60.2								
	7	36.5	23.2			25.1	11.8	33.8	20.5	42.4	29.1	51.0	37.7	59.6	46.3	68.3	55.0	76.9	63.6						
	8	41.7	26.5					30.4	15.2	39.1	23.9	47.7	32.5	56.3	41.1	64.9	49.7	73.6	58.4	90.8	75.6				
	9	46.9	29.8							35.8	18.7	44.4	27.3	53.0	35.9	61.6	44.5	70.3	53.2	87.5	70.4	104.8	87.7		
	10	52.1	33.1							32.5	13.5	41.1	22.1	49.7	30.7	58.3	39.3	67.0	48.0	84.2	65.2	101.5	82.5		
	11	57.3	36.4							29.1	8.2	37.8	16.9	46.4	25.5	55.0	34.1	63.6	42.7	80.9	60.0	98.1	77.2		
12	62.5	39.7							25.8	3.0	34.5	11.7	43.1	20.3	51.7	28.9	60.3	37.5	77.6	54.8	94.8	72.0			

# Spring return - Output torque

Size	Spring qty	Spring torque (Nm)		Air supply pressure (bar)																					
				2.5		3		3.5		4		4.5		5		5.5		6		7		8			
		90°	0°	Output torque of spring return (Nm)																					
		0°	90°	0°	90°	0°	90°	0°	90°	0°	90°	0°	90°	0°	90°	0°	90°	0°	90°	0°	90°	0°	90°		
95	S5	34.9	22.1	33.6	20.9	45.8	33.0	57.9	45.1	70.0	57.3	82.1	69.4	94.3	81.5										
	S6	41.8	26.5	29.2	13.9	41.4	26.1	53.5	38.2	65.6	50.3	77.7	62.4	89.8	74.5	102.0	86.7								
	S7	48.8	30.9			36.9	19.1	49.1	31.2	61.2	43.3	73.3	55.4	85.4	67.6	97.5	79.7	109.7	91.8						
	S8	55.8	35.4					44.6	24.2	56.8	36.4	68.9	48.5	81.0	60.6	93.1	72.7	105.2	84.8	129.5	109.1				
	S9	62.7	39.8							52.3	29.4	64.5	41.5	76.6	53.6	88.7	65.8	100.8	77.9	125.1	102.1	149.3	126.4		
	S10	69.7	44.2							47.9	22.4	60.0	34.5	72.2	46.7	84.3	58.8	96.4	70.9	120.6	95.1	144.9	119.4		
	S11	76.7	48.6							43.5	15.4	55.6	27.6	67.7	39.7	79.9	51.8	92.0	63.9	116.2	88.2	140.5	112.4		
	S12	83.6	53.0							39.1	8.5	51.2	20.6	63.3	32.7	75.4	44.8	87.6	57.0	111.8	81.2	136.0	105.4		
110	S5	45.9	28.6	43.4	26.2	60.7	43.4	76.4	59.1	92.0	74.8	107.7	90.4	123.4	106.1										
	S6	55.0	34.3	37.7	17.0	55.0	34.3	70.6	49.9	86.3	65.6	102.0	81.3	117.6	96.9	133.3	112.6								
	S7	64.2	40.0			49.3	25.1	64.9	40.8	80.6	56.4	96.2	72.1	111.9	87.8	127.6	103.4	143.2	119.1						
	S8	73.4	45.8					59.2	31.6	74.9	47.3	90.5	62.9	106.2	78.6	121.9	94.3	137.5	109.9	168.9	141.3				
	S9	82.5	51.5							69.1	38.1	84.8	53.8	100.5	69.4	116.1	85.1	131.8	100.8	163.1	132.1	194.5	163.4		
	S10	91.7	57.2							63.4	28.9	79.1	44.6	94.8	60.3	110.4	75.9	126.1	91.6	157.4	122.9	188.7	154.2		
	S11	100.9	62.9							57.7	19.8	73.4	35.4	89.0	51.1	104.7	66.7	120.4	82.4	151.7	113.7	183.0	145.1		
	S12	110.0	68.6							52.0	10.6	67.6	26.2	83.3	41.9	99.0	57.6	114.6	73.2	146.0	104.6	177.3	135.9		
125	S5	80.6	51.0	77.7	48.2	108.5	78.9	136.5	106.9	164.4	134.9	192.4	162.9	220.4	190.9										
	S6	96.7	61.2	67.5	32.0	98.3	62.8	126.3	90.8	154.2	118.8	182.2	146.8	210.2	174.7	238.2	202.7								
	S7	112.8	71.4			88.1	46.7	116.1	74.7	144.0	102.7	172.0	130.7	200.0	158.6	228.0	186.6	256.0	214.6						
	S8	128.9	81.6					105.9	58.6	133.8	86.6	161.8	114.5	189.8	142.5	217.8	170.5	245.8	198.5	301.7	254.4				
	S9	145.0	91.8							123.6	70.5	151.6	98.4	179.6	126.4	207.6	154.4	235.6	182.4	291.5	238.3	347.5	294.3		
	S10	161.1	102.0							113.4	54.3	141.4	82.3	169.4	110.3	197.4	138.3	225.4	166.3	281.3	222.2	337.3	278.2		
	S11	177.2	112.2							103.2	38.2	131.2	66.2	159.2	94.2	187.2	122.2	215.2	150.2	271.1	206.1	327.1	262.1		
	S12	193.3	122.4							93.0	22.1	121.0	50.1	149.0	78.1	177.0	106.1	205.0	134.0	260.9	190.0	316.9	246.0		
140	S5	122.4	82.3	114.2	74.1	155.1	115.0	196.1	156.0	237.0	196.9	277.9	237.8	318.8	278.7										
	S6	146.8	98.7	97.7	49.6	138.7	90.6	179.6	131.5	220.5	172.4	261.5	213.3	302.4	254.3	343.3	295.2								
	S7	171.3	115.2			122.2	66.1	163.2	107.0	204.1	147.9	245.0	188.9	285.9	229.8	326.9	270.7	367.8	311.6						
	S8	195.8	131.6					146.7	82.5	187.6	123.5	228.6	164.4	269.5	205.3	310.4	246.2	351.3	287.2	433.2	369.0				
	S9	220.2	148.1							171.2	99.0	212.1	139.9	253.0	180.9	294.0	221.8	334.9	262.7	416.7	344.6	498.6	426.4		
	S10	244.7	164.5							154.7	74.5	195.7	115.5	236.6	156.4	277.5	197.3	318.4	238.2	400.3	320.1	482.1	401.9		
	S11	269.2	181.0							138.3	50.1	179.2	91.0	220.1	131.9	261.1	172.8	302.0	213.8	383.8	295.6	465.7	377.5		
	S12	293.6	197.4							121.8	25.6	162.8	66.5	203.7	107.4	244.6	148.4	285.5	189.3	367.4	271.1	449.2	353.0		
160	S5	162.3	110.0	153.5	101.3	216.6	164.4	273.9	221.7	331.2	279.0	388.5	336.3	445.8	393.6										
	S6	194.7	132.0	131.5	68.8	194.6	131.9	251.9	189.2	309.2	246.5	366.5	303.8	423.8	361.1	481.1	418.4								
	S7	227.2	154.0			172.6	99.5	229.9	156.8	287.2	214.1	344.5	271.4	401.8	328.7	459.1	386.0	516.4	443.3						
	S8	259.6	176.0					207.9	124.3	265.2	181.6	322.5	238.9	379.8	296.2	437.1	353.5	494.4	410.8	609.0	525.4				
	S9	292.1	198.0							243.2	149.2	300.5	206.5	357.8	263.8	415.1	321.1	472.4	378.4	587.0	493.0	701.7	607.6		
	S10	324.5	220.0							221.2	116.7	278.5	174.0	335.8	231.3	393.1	288.6	450.4	345.9	565.0	460.5	679.7	575.2		
	S11	357.0	242.0							199.2	84.3	256.5	141.6	313.8	198.9	371.1	256.2	428.4	313.5	543.0	428.1	657.7	542.7		
	S12	389.4	264.0							177.2	51.8	234.5	109.1	291.8	166.4	349.1	223.7	406.4	281.0	521.0	395.6	635.7	510.3		
190	S5	261.2	181.8	246.8	167.4	336.3	256.9	425.6	346.2	514.9	435.5	604.2	524.8	693.5	614.1										
	S6	313.4	218.1	210.4	115.1	299.9	204.6	389.2	293.9	478.5	383.3	567.8	472.6	657.2	561.9	746.5	651.2								
	S7	365.6	254.5			263.6	152.4	352.9	241.7	442.2	331.0	531.5	420.3	620.8	509.6	710.1	599.0	799.4	688.3						
	S8	417.8	290.8					316.5	189.5	405.8	278.8	495.1	368.1	584.5	457.4	673.8	546.7	763.1	636.0	941.7	814.7				
	S9	470.1	327.2							369.5	226.6	458.8	315.9	548.1	405.2	637.4	494.5	726.7	583.8	905.3	762.4	1084.0	941.1		
	S10	522.3	363.5							333.1	174.3	422.4	263.6	511.8	353.0	601.1	442.3	690.4	531.6	869.0	710.2	1047.6	888.8		
	S11	574.5	399.9							296.8	122.1	386.1	211.4	475.4	300.7	564.7	390.0	654.0	479.3	832.6	658.0	1011.3	836.6		
	S12	626.8	436.2							260.4	69.9	349.7	159.2	439.1	248.5	528.4	337.8	617.7	427.1	796.3	605.7	974.9	784.4		

# Spring return - Output torque

Size	Spring qty	Spring torque (Nm)		Air supply pressure (bar)																			
				2.5		3		3.5		4		4.5		5		5.5		6		7		8	
		90°	0°	Output torque of spring return (Nm)																			
		0°	90°	0°	90°	0°	90°	0°	90°	0°	90°	0°	90°	0°	90°	0°	90°	0°	90°	0°	90°		
210	S5	359.1	245.4	352.8	239.1	477.8	364.1	602.5	488.8	727.2	613.5	851.9	738.2	976.6	862.9								
	S6	430.9	294.5	303.7	167.3	428.7	292.3	553.4	417.0	678.1	541.7	802.8	666.4	927.5	791.0	1052.2	915.7						
	S7	502.7	343.6			379.6	220.5	504.3	345.2	629.0	469.8	753.7	594.5	878.4	719.2	1003.1	843.9	1127.8	968.6				
	S8	574.6	392.6					455.3	273.3	579.9	398.0	704.6	522.7	829.3	647.4	954.0	772.1	1078.7	896.8	1328.1	1146.2		
	S9	646.4	441.7							530.9	326.2	655.6	450.9	780.2	575.6	904.9	700.3	1029.6	825.0	1279.0	1074.3	1528.4	1323.7
	S10	718.2	490.8							481.8	254.4	606.5	379.1	731.2	503.8	855.8	628.4	980.5	753.1	1229.9	1002.5	1479.3	1251.9
	S11	790.0	539.9							432.7	182.6	557.4	307.3	682.1	431.9	806.8	556.6	931.5	681.3	1180.8	930.7	1430.2	1180.1
	S12	861.8	589.0							383.6	110.7	508.3	235.4	633.0	360.1	757.7	484.8	882.4	609.5	1131.8	858.9	1381.1	1108.3
240	S5	554.0	410.5	543.3	399.8	711.2	567.7	904.6	761.1	1098.0	954.5	1291.4	1147.9	1484.8	1341.3								
	S6	664.8	492.6	461.2	289.0	629.1	456.9	822.5	650.3	1015.9	843.7	1209.3	1037.1	1402.7	1230.5	1596.1	1423.9						
	S7	775.6	574.7			547.0	346.1	740.4	539.5	933.8	732.9	1127.2	926.3	1320.6	1119.7	1514.0	1313.1	1707.4	1506.5				
	S8	886.4	656.8					658.3	428.7	851.7	622.1	1045.1	815.5	1238.5	1008.9	1431.9	1202.3	1625.3	1395.7	2012.1	1782.5		
	S9	997.2	738.9							769.6	511.3	963.0	704.7	1156.4	898.1	1349.8	1091.5	1543.2	1284.9	1930.0	1671.7	2316.8	2058.5
	S10	1108.0	821.0							687.5	400.5	880.9	593.9	1074.3	787.3	1267.7	980.7	1461.1	1174.1	1847.9	1560.9	2234.7	1947.7
	S11	1218.8	903.1							605.4	289.7	798.8	483.1	992.2	676.5	1185.6	869.9	1379.0	1063.3	1765.8	1450.1	2152.6	1836.9
	S12	1329.6	985.2							523.3	178.9	716.7	372.3	910.1	565.7	1103.5	759.1	1296.9	952.5	1683.7	1339.3	2070.5	1726.1
270	S5	786.0	559.5	769.8	543.3	1047.6	821.1	1324.7	1098.2	1601.8	1375.3	1878.9	1652.4	2156.0	1929.5								
	S6	943.2	671.4	657.9	386.1	935.7	663.9	1212.8	941.0	1489.9	1218.1	1767.0	1495.2	2044.1	1772.3	2321.2	2049.4						
	S7	1100.4	783.3			823.8	506.7	1100.9	783.8	1378.0	1060.9	1655.1	1338.0	1932.2	1615.1	2209.3	1892.2	2486.3	2169.2				
	S8	1257.6	895.2					989.0	626.6	1266.1	903.7	1543.2	1180.8	1820.3	1457.9	2097.4	1735.0	2374.4	2012.0	2928.6	2566.2		
	S9	1414.8	1007.1							1154.2	746.5	1431.3	1023.6	1708.4	1300.7	1985.5	1577.8	2262.5	1854.8	2816.7	2409.0	3370.9	2963.2
	S10	1572.0	1119.0							1042.3	589.3	1319.4	866.4	1596.5	1143.5	1873.6	1420.6	2150.6	1697.6	2704.8	2251.8	3259.0	2806.0
	S11	1729.2	1230.9							930.4	432.1	1207.5	709.2	1484.6	986.3	1761.7	1263.4	2038.7	1540.4	2592.9	2094.6	3147.1	2648.8
	S12	1886.4	1342.8							818.5	274.9	1095.6	552.0	1372.7	829.1	1649.8	1106.2	1926.8	1383.2	2481.0	1937.4	3035.2	2491.6
300	S5	1031.9	691.1	987.5	646.7	1338.3	997.5	1688.2	1347.4	2038.1	1697.3	2388.0	2047.2	2737.9	2397.1								
	S6	1238.3	829.3	849.3	440.3	1200.1	791.1	1550.0	1141.0	1899.9	1490.9	2249.8	1840.8	2599.6	2190.7	2949.5	2540.6						
	S7	1444.7	967.5			1061.9	584.7	1411.7	934.6	1761.6	1284.5	2111.5	1634.4	2461.4	1984.3	2811.3	2334.2	3161.2	2684.1				
	S8	1651.0	1105.8					1273.5	728.2	1623.4	1078.1	1973.3	1428.0	2323.2	1777.9	2673.1	2127.8	3023.0	2477.7	3722.8	3177.5		
	S9	1857.4	1244.0							1485.2	871.8	1835.1	1221.7	2185.0	1571.5	2534.9	1921.4	2884.8	2271.3	3584.6	2971.1	4284.4	3670.9
	S10	2063.8	1382.2							1347.0	665.4	1696.9	1015.3	2046.8	1365.2	2396.7	1715.1	2746.6	2065.0	3446.3	2764.7	4146.1	3464.5
	S11	2270.2	1520.4							1208.8	459.0	1558.7	808.9	1908.5	1158.8	2258.4	1508.7	2608.3	1858.6	3308.1	2558.4	4007.9	3258.2
	S12	2476.6	1658.6							1070.5	252.6	1420.4	602.5	1770.3	952.4	2120.2	1302.3	2470.1	1652.2	3169.9	2352.0	3869.7	3051.8
350	S5	1475.5	994.3	1498.2	1017.1	2017.5	1536.4	2536.8	2055.6	3056.1	2574.9	3575.3	3094.2	4094.6	3613.5								
	S6	1770.5	1193.2			1818.6	1241.3	2337.9	1760.5	2857.2	2279.8	3376.5	2799.1	3895.8	3318.4	4415.0	3837.7						
	S7	2065.6	1392.0			1619.8	946.2	2139.1	1465.5	2658.3	1984.7	3177.6	2504.0	3696.9	3023.3	4216.2	3542.6	4735.5	4061.8				
	S8	2360.7	1590.9					1940.2	1170.4	2459.5	1689.6	2978.8	2208.9	3498.0	2728.2	4017.3	3247.5	4536.6	3766.8	5575.1	4805.3		
	S9	2655.8	1789.7					1741.3	875.3	2260.6	1394.6	2779.9	1913.8	3299.2	2433.1	3818.5	2952.4	4337.7	3471.7	5376.3	4510.2	6414.8	5548.8
	S10	2950.9	1988.6							2061.8	1099.5	2581.0	1618.7	3100.3	2138.0	3619.6	2657.3	4138.9	3176.6	5177.4	4215.1	6216.0	5253.7
	S11	3246.0	2187.5							1862.9	804.4	2382.2	1323.7	2901.5	1842.9	3420.7	2362.2	3940.0	2881.5	4978.6	3920.0	6017.1	4958.6
	S12	3541.1	2386.3							1664.0	509.3	2183.3	1028.6	2702.6	1547.8	3221.9	2067.1	3741.2	2586.4	4779.7	3624.9	5818.3	4663.5
400	S5	2301.0	1576.0	2222.1	1497.1	3013.4	2288.4	3804.7	3079.7	4596.0	3871.0	5387.3	4662.3	6178.5	5453.5								
	S6	2761.2	1891.2			2698.2	1828.2	3489.5	2619.5	4280.8	3410.8	5072.1	4202.1	5863.3	4993.3	6654.6	5784.6						
	S7	3221.4	2206.4			2383.0	1368.0	3174.3	2159.3	3965.6	2950.6	4756.9	3741.9	5548.1	4533.1	6339.4	5324.4	7130.7	6115.7				
	S8	3681.6	2521.6					2859.1	1699.1	3650.4	2490.4	4441.7	3281.7	5232.9	4072.9	6024.2	4864.2	6815.5	5655.5	8398.1	7238.1		
	S9	4141.8	2836.8					2543.9	1238.9	3335.2	2030.2	4126.5	2821.5	4917.7	3612.7	5709.0	4404.0	6500.3	5195.3	8082.9	6777.9	9665.4	8360.4
	S10	4602.0	3152.0							3020.0	1570.0	3811.3	2361.3	4602.5	3152.5	5393.8	3943.8	6185.1	4735.1	7767.7	6317.7	9350.2	7900.2
	S11	5062.2	3467.2							2704.8	1109.8	3496.1	1901.1	4287.3	2692.3	5078.6	3483.6	5869.9	4274.9	7452.5	5857.5	9035.0	7440.0
	S12	5522.4	3782.4							2389.6	649.6	3180.9	1440.9	3972.1	2232.1	4763.4	3023.4	5554.7	3814.7	7137.3	5397.3	8719.8	6979.8

# Actuator interface for valve automation

## Actuator interface for valve automation and mounting standard

VDI/VDE 3845 standard  
for easy top mounting of  
switches, positioners etc.

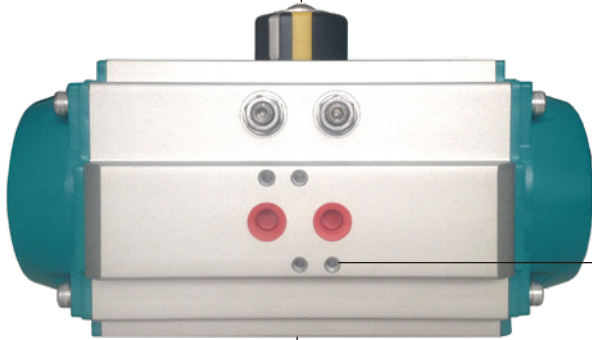

NAMUR air supply  
connection to install  
solenoid valve directly

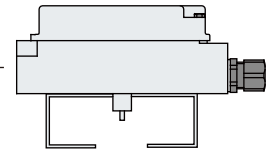

Positioner

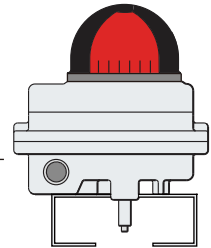

Limit box

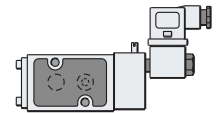

Solenoid valve



ISO 5211 - DIN 3337 bottom  
mounting connection for direct  
mounting on valves

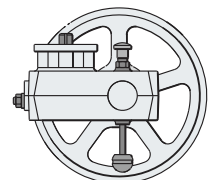

Declutchable gear box

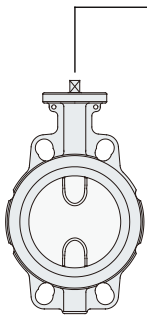

Concentric butterfly valve

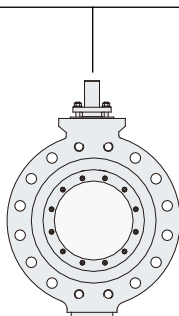

Eccentric butterfly valve

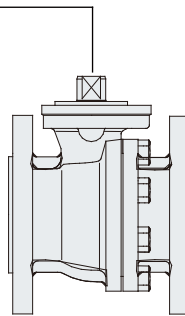

Ball valve

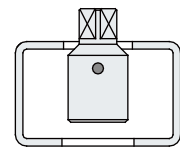

Mounting kits

## Technical data

### Working time, air consumption, weight

Size	Working time				Air consumption		Weight	
	Double acting		Spring return		Double acting & Spring return		Double acting	Spring return
	Open time [s]	Close time [s]	Open time [s]	Close time [s]	Open volume [L]	Close volume [L]	[kg]	[kg]
32	0.30	0.40	0.30	0.40	0.03	0.04	0.47	0.59
40	0.20	0.30	0.60	0.80	0.08	0.11	1.00	1.10
50	0.30	0.40	0.90	0.70	0.09	0.15	1.13	1.25
65	0.40	0.40	0.90	0.80	0.19	0.32	1.97	2.21
75	0.40	0.40	0.90	0.90	0.30	0.50	2.93	3.29
85	0.90	0.90	1.00	1.20	0.44	0.66	3.78	4.26
95	0.90	1.00	1.40	1.40	0.88	1.17	5.14	5.86
110	0.90	1.00	1.40	1.60	0.83	1.27	6.09	7.17
125	1.30	1.40	2.40	2.40	1.41	2.13	10.86	12.54
140	1.30	1.40	2.80	3.00	1.76	2.72	13.77	15.93
160	2.00	2.40	4.80	4.90	2.85	4.08	20.15	23.75
190	2.20	2.60	2.40	3.00	4.75	7.20	28.41	33.81
210	2.90	3.80	3.40	4.10	6.60	10.29	40.03	48.43
240	3.20	3.70	3.81	4.00	11.40	15.10	52.60	77.76
270	4.40	4.90	5.00	5.50	15.80	18.80	73.64	90.60
300	5.00	6.00	6.00	6.80	19.09	28.23	108.00	135.60
350	6.20	7.20	7.40	8.40	27.65	44.10	146.70	188.10
400	7.50	8.50	9.60	10.60	42.81	62.05	220.50	283.50

\* Size 32 is only available for double acting type.

\*\* Spring quantity: S12.

#### Notes:

- Operating times under no load, with air supply pressure 5.5bar. Time based on actual measurement.
- Total time is defined as time required from switching solenoid valve to completion of 90 degree stroke.
- 32-160: Diameter of solenoid valve 4mm with flow capacity 400L/min, air pipe diameter 6mm;  
190-400: Diameter of solenoid valve 12mm with flow capacity 5100L/min, air pipe diameter 8mm.
- Stroke times can be decreased by using speed control.
- Air Consumption:  
Litre shown in chart represent actual free air volume in either open or close direction.  
Air consumption will vary depending on air supply pressure, open/close volume and the number of strokes per minute .  
To determine standard litre per minute use the following formula:

$$\text{Air consumption (L/min)} = (\text{open+close volume.L}) \times \frac{\text{air supply pressure.Kpa}+101.3}{101.3} \times \text{strokes/min}$$



### **Solenoid valve**

- 5/2 and 3/2 NC.
- Single coil and double coil.
- Wide range voltage both for DC and AC.
- Namur connection both for 1/4" and 1/2".



### **Explosion-proof solenoid valve**

- Environmentally-protected structure with explosion-proof Exd II CT6.
- Extruded enclosure with weather proof IP66.
- F class coil of insulation protection.
- SS316 body material available on request.



### **Position switch box**

- Compact design with visual indicator.
- Easy and safe adjustment of limit switch.
- Mechanical switches, proximity sensor.
- 4-20mA current feedback is available with multi-function type.



### **Explosion-proof position switch box**

- Explosion-proof Exd II CT6 or Exd II BT6.
- Compact design with visual indicator.
- Easy and safe adjustment of limit switch.
- Mechanical switches, proximity sensor.



### **Intelligent positioner**

- Full digital control, reliability, stability, small size and light weight.
- Convenient for adjustment by simple buttons.
- Simple function setting, convenient for the transform of positive action and counteraction, valve open and closing.
- Intelligent control. It can give analysis, alarm and optimization when medium fluctuates, span excesses, actuator leakage occurs.



### **Electron-pneumatic positioner**

- High anti-vibration.
- Split-range operation by inputting electrical signals.
- Exquisite design.
- Putting in and out cam is available without disassembling feedback level.
- Convenient for ZREO and SPAN adjustments.
- Convenient for on-side maintenance.



### **Air pressure filter**

- Stable outlet pressure regardless of the fluctuation of inputting pressure or flow rate.
- Easy to install and maintain due to light weight and small size.
- To filter minuteness particle is available with 5 micron filter.
- Relief function which discharges to atmosphere if outlet pressure is higher than setting pressure.



# Installation guide

## Warning

- Make sure only qualified person can carry out the mounting, assembly and disassembly of the actuators.
- Isolate the actuator from air supply before doing any adjusting, mounting or maintenance work.
- Do not operate the actuator over pressure limits: this could damage internal parts as well as cause damage to the housing and end caps.
- Never use the adjust screws to pressure against the operating pressure.

## Setting the end positions

Adjustment of the end positions is performed via adjust screws.

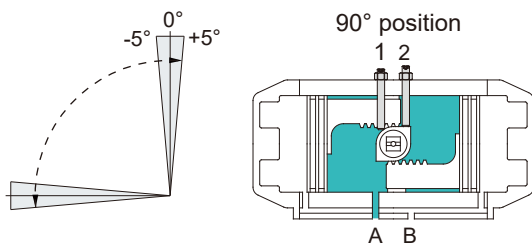

When driving shaft turns counterclockwise:  
Loosen the locknut and turn the end position adjust screw 2 inwards/outwards until the desired position is reached.  
Secure the position by tightening the locknut.

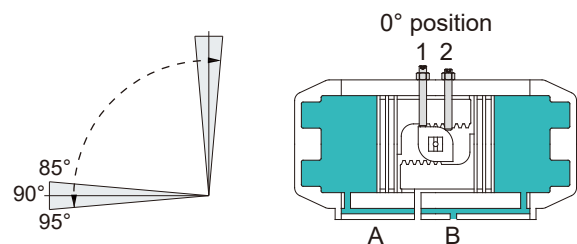

When driving shaft turns clockwise:  
Loosen the locknut and turn the end position adjust screw 1 inwards/outwards until the desired position is reached.  
Secure the position by tightening the locknut.

## Assembly of the valve

1. Determine the desired operation of assembly: Normally closed NC, or Normally open NO.
2. Make sure the supply air pressure is minimum same or higher than used by the calculation for sizing the actuator.
3. Make sure that the rotation direction and the position indicator are in the correct position.
4. Ensure the mounting screws is proportionally fastened with correct torque.
5. Fit the stem of the valve directly into the square of the actuator. Use an additional adaptor if needed.
6. Bolt the valve and actuator together through the valve ISO pad. Make sure the force is proportionally distributed in circle.
7. When using a spring return actuator for fail safe operation, ensure that when air or electricity failure occurs the direction of rotation is correct for your application.
8. Ensure temperature is not higher than max. limit of actuator.
9. Ensure supply air quality is accordance with ISO8573 Part 1, Class 5 with the maximum particle size not exceeding 30µm.



## Disassembly of the actuator

Before performing any disassembly operations, it is important to verify that the actuator is not pressurised. Relief air from actuator and then remove from the valve.

For spring return actuator, make sure that the actuator is in the failed position and with pistons completely inwards before disassembly.

1. Remove the indicator screw (1) and washer (2) if fitted, lift position indicator (3) off pinion, it may be necessary to pry gently with a screw-driver.
2. Remove the nut cover (19), unscrew both adjust screws (18) together with nut (17), washer (16) and O-ring (15).
3. Unscrew the end caps screw (28) and remove the end cap (27) and O-ring (26). Remember to disassemble one end cap at one time. For spring return type, then remove the springs (25).

# Installation guide

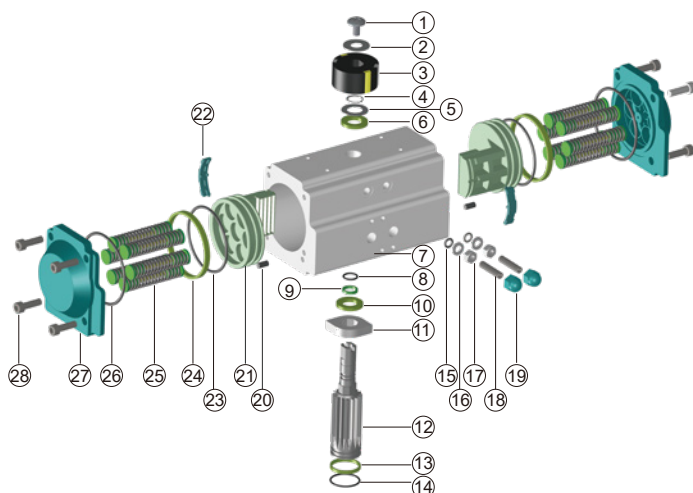

No.	Part name	Qty	No.	Part name	Qty
1	Cap screw (Indicator)	1	15	O-ring (Adjust screw)	2
2	Washer (Indicator)	1	16	Washer (Adjust screw)	2
3	Position indicator	1	17	Nut (Adjust screw)	2
4	Spring clip (Pinion)	1	18	Adjust screw	2
5	Thrust washer	1	19	Nut cover (Adjust screw)	2
6	Thrust bearing (Pinion)	1	20	Plug	2
7	Body	1	21	Piston	2
8	O-ring (Pinion top)	1	22	Plate (Piston)	2
9	Bearing (Pinion top)	1	23	O-ring (Piston)	2
10	Thrust bearing (Pinion)	1	24	Bearing (Piston)	2
11	OCTI Cam (Stop arrangement)	1	25	Spring	0~12
12	Pinion	1	26	O-ring (End cap)	2
13	Bearing (Pinion bottom)	1	27	End cap	2
14	O-ring (Pinion bottom)	1	28	Cap screw	8

4. Holding the body (7), rotate the pinion until the pistons (21) are released.
5. Remove the spring clip (4), thrust washer (5) and bearing (6).
6. Exert a downwards force on top of the pinion to remove the pinion (12), cam (11), pinion top bearing (9) and O-ring (8), pinion bottom bearing (13) and O-ring (14).
7. Clean all the components of the actuators, inspect them for wear or damage and replace where necessary.

## Assembly of the actuator

Before assembly, make sure that all the components are perfectly clean and in good condition. The spare parts and the lubricant used are suitable for the operating temperature of the actuator.

1. Install top (9) and bottom (13) bearings, grease and insert the top (8) and bottom (14) O-rings on to the pinion.
2. Refit the pinion (12) into the actuator body (7) ensuring the cam (11) correctly fit during assembly.
3. Fix the thrust bearing (6), washer (5) and spring clip (4) to the top of the pinion.
4. Install the piston plate (22) and bearing (24), grease and insert the O-ring (23) on to the piston.
5. Insert and press the two pistons (21) simultaneously inside the body (7) ensuring that the rack on each of the piston fit in with the rack of the pinion.
6. For standard rotation assembly, rotate the body about 40-45° clockwise from top view until the pistons are correctly reacted. Check that the pinion output end is square to the body is in the correctly aligned.
7. Fit the end cap O-ring (26) into the groove on both end caps (27).
8. For spring return actuators, insert the springs in each end cap according to the desired configuration.
9. Fit end caps onto the body and tighten the screws (28) proportionally with correct torque value.
10. Fit the stroke adjustment screw (18) with nut (17), washer (16) and O-ring (15).

## Storage instructions

- Store the actuator in a dry and clean area.
- Protect the air supply entrances from dust by fitting in the original plastic cover.
- Packing the actuator in box or plastic bag to avoid dust, dirt and damage.

# Coreline

The contents of this catalogue are confidential and proprietary to Coreline, we reserve the right to change the specifications without any notice.

## CORELINE VALVE CO., LTD.

Add: No.210 Xinyuan Road, Ehu Industrial Park, 214116 Wuxi, China

Phone: +86 510 8852 5336

Http: // www.coreline.dk

E-mail : mail@coreline.cn