



**MAGNETROL®**



**LEVEL MEASUREMENT  
SOLUTIONS**

## Model T10 Float Level Switch

### DESCRIPTION

The Magnetrol® Model T10 float level switch offers industrial and municipal users a low-cost solution to wide differential level applications. The moving ballast causes a flipping motion of the float to provide positive switching action even under turbulent conditions. Recommended for use in either clean or dirty liquids, it is ideal for use in sump control, wet well applications and pilot systems.

### FEATURES

- Differential band 20, 40, or 60 feet (determined by cable length)
- May be wired for automatic fill or empty cycles
- Dry contact switch mechanism
- Cable CSA (SJTO) approved
- Switch chatter eliminated with moving ballast
- Single float with simple control circuit eliminates the need for latching devices or double switching with two units
- Specific gravity range of 0.6 to 1.5
- Positive switching action—even in turbulent conditions
- Cable anchoring point protected by adjustable strain relief
- All PVC exposed components make it resistant to water-based chemicals
- Mounts easily by cable tie (included) or optional cable weight

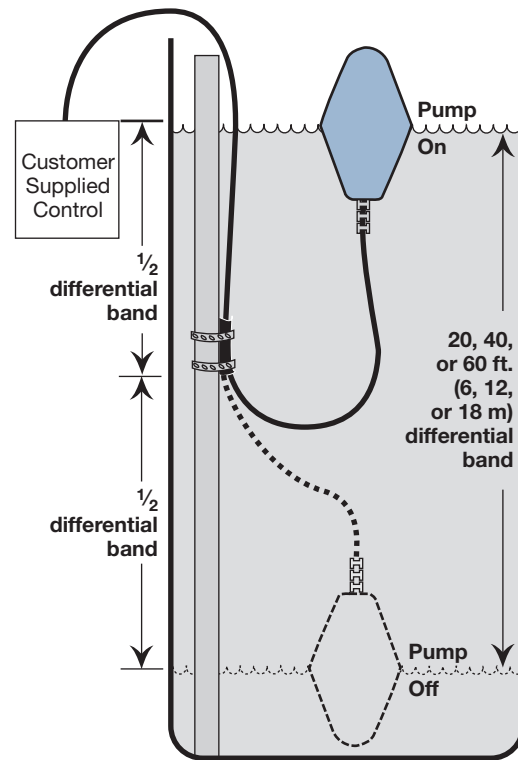

### APPLICATIONS

- Water and wastewater
- PVC compatible caustics
- PVC compatible chemicals
- PVC compatible acids

### MODEL NUMBERS



Model T10-5104-020 is available for quick shipment, usually within one week after factory receipt of a complete purchase order, through the Expedite Ship Plan (ESP)

T10-5104-020	Dry contact switch mechanism, 20 ft. (6 m) maximum differential band, 20 ft. (6 m) cable
T10-5104-040	Dry contact switch mechanism, 40 ft. (12 m) maximum differential band, 40 ft. (12 m) cable
T10-5104-060	Dry contact switch mechanism, 60 ft. (18 m) maximum differential band, 60 ft. (18 m) cable
089-5209-001	Cable weight accessory kit containing weight, clamp, and two screws

# SPECIFICATIONS

Switch type	SPDT dry contact
Process temperature	+140 °F (+60 °C) maximum
Ambient temperature	+32 to +140 °F (0 to +60 °C)
Specific gravity	0.6 minimum / 1.5 maximum
Maximum float switch current	12A @ +32 to +86 °F (0 to +30 °C); subtract 0.6A for every +9° F (+5° C) rise above +86° F (+30° C)
Maximum float switch voltage	250 VDC / 250 VAC <sub>RMS</sub>
Float switch ratings	DC (resistive & inductive): 12A maximum @ 0 to 50V, +32 to +86 °F (0 to +30 °C) 0.6A/0.3A @ 125V/250
	AC (resistive & inductive): 12A maximum @ 125 to 250V, +32 to +86 °F (0 to +30 °C)
	Horse power: 1/2HP
	Minimum contact life: 100,000 operations
Differential band	18 inches (457 mm) minimum / 60 feet (18 meters) maximum
Materials of construction	Polyvinyl chloride (PVC) with adjustable neoprene strain relief and Buna cosmetic ring
Cable size	18 AWG (3 x 1.5 mm) 41 strands

# PRINCIPLE OF OPERATION

**Figure 1**

T10 level switches contain a dry contact switch with a swinging ballast. The cable on the float is anchored in the tank at the mid-point of the differential band.

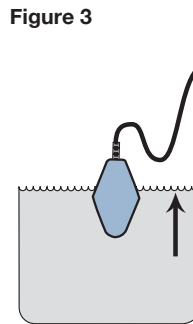
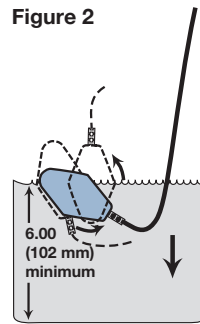
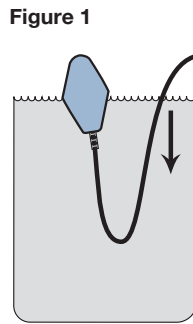
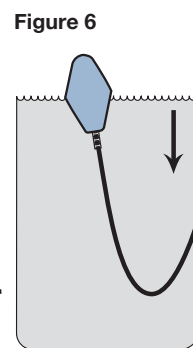
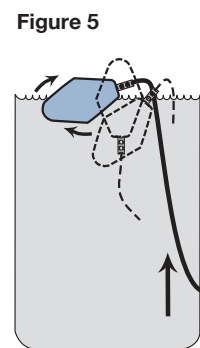
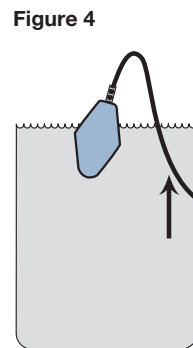

**Figure 4**

Contacts have not yet changed state with rise in level.

**Figure 5**

As the highest point of the differential is reached, the cable is again pulled taut, tilting the float, causing the ballast to swing back to its original position in the float. The float flips, causing the switch contacts to return to their original state. This cycle repeats as the level changes.



**Figure 6**

The differential band equals twice the length of cable from its point of attachment to the strain relief, to the point at which it is anchored. For an alarm function, use a minimum differential band of 18.00 inches (457 mm).

**Figure 3**

Since the float remains in this position even under turbulent conditions, switch chatter is eliminated.

# MOUNTING PROCEDURE

T10 level switch may be mounted by using cable ties included with the unit, or by the optional cable weight which must be purchased separately.

**CAUTION:** The recommended method of carrying the T10 is by the cable. The unique moving ballast in the unit may cause it to unexpectedly flip out of the individual's hands.

## Cable tie method (standard)

A pipe or other structure must be available in the tank to which the plastic cable tie may be affixed. Refer to Figure 7.

Position the adjustable strain relief on the cable to allow one-half of the distance of the differential band between the end of this strain relief and the end of the strain relief on the float.

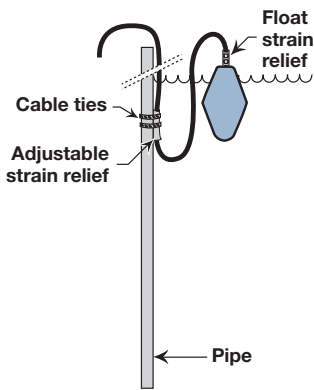

Figure 7

Secure the cable to the structure with one cable tie at the midpoint of the strain relief. Secure the second cable tie to the structure at the top end of the adjustable strain relief, leaving approximately two inches (51 mm) of free strain relief towards the float. Proceed to wire the unit.

**NOTE:** Be sure that nothing in the tank prevents the full extension of the cable in either direction.

## Cable weight method (optional)

When an anchoring structure in the tank is not available, the cable weight method should be used. Refer to Figure 8.

Position the adjustable strain relief on the cable to allow one half the distance of the desired differential band between the midpoint of the adjustable strain relief on the float.

Remove one of the screws in the clamp at the top of the weight. Loosen the second screw. Refer to Figure 9. Position the weight at the midpoint of the adjustable strain relief. Tighten both screws to secure the weight to the cable. Be sure the cable cannot be pulled through the adjustable strain relief. Lower the unit in the tank until the cable weight is positioned at the midpoint of the desired differential band. Secure the cable at the top of the tank. DO NOT secure the cable to any sharp object which could cut the cable. Proceed to wire the unit.

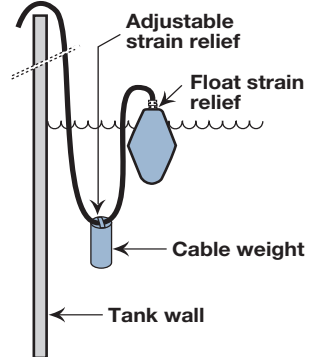

Figure 8

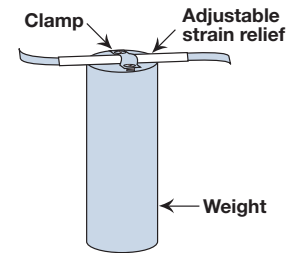
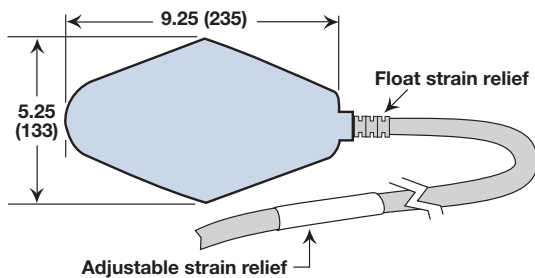

Figure 9

## DIMENSIONAL Inches (mm)

### Model T10



**NOTE:** Minimum distance between anchor point on adjustable strain relief and float strain relief is 9.00 inches (229).

### Cable weight (optional)

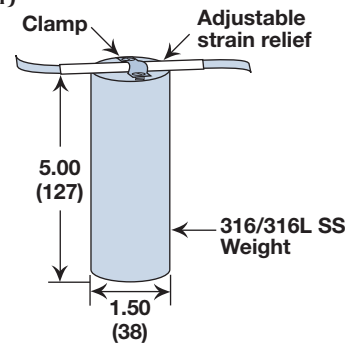

**NOTE:** Cable floats not provided with 20' cable, one float provided with 40' cable, and two floats provided with 60' cable.

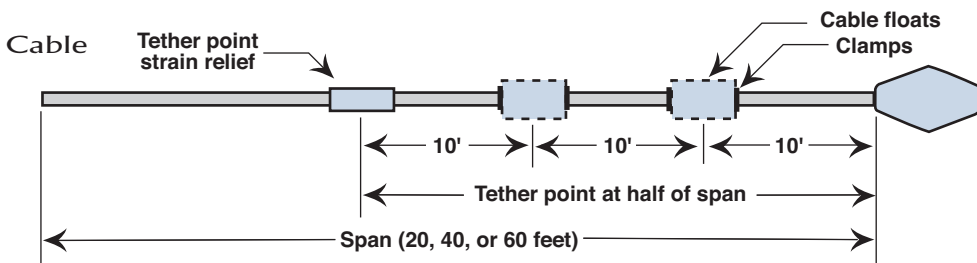

# WIRING PROCEDURE

The T10 float level switch may be wired for fill or empty pump control functions or as a high or low level alarm. Wire according to the terminal connection drawing below.

## CAUTION:

1. The unused wire (third wire) must be electrically insulated.
2. Do not fasten electrical cable onto rough or sharp surfaces.
3. Use only on equipment with thermal overload protection.
4. Consult local codes for proper application.

## FOR EMPTY PUMP CONTROL OR HIGH ALARM FUNCTIONS

Connect the blue and black wires.

## FOR FILL PUMP CONTROL OR LOW ALARM FUNCTIONS

Connect the blue and brown wires.

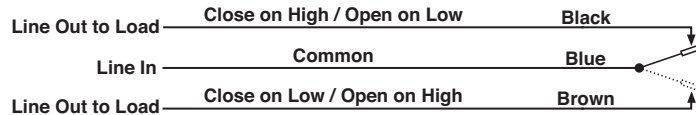

# QUALITY



The quality assurance system in place at Magnetrol® guarantees the highest level of quality throughout the company. Magnetrol is committed to providing full customer satisfaction both in quality products and quality service.

The Magnetrol quality assurance system is registered to ISO 9001 affirming its commitment to known international quality standards providing the strongest assurance of product/service quality available.

# ESP

**E**xpedite  
**S**hip  
**P**lan

Model T10-5104-020 is available for quick shipment, usually within one week after factory receipt of a complete purchase order, through the Expedite Ship Plan (ESP).

ESP service may not apply to orders of ten units or more. Contact your local representative for lead times on larger volume orders, as well as other products and options.

# WARRANTY



All Magnetrol mechanical level and flow controls are warranted free of defects in materials or workmanship for three full years from the date of original factory shipment.

If returned within the warranty period; and, upon factory inspection of the control, the cause of the claim is determined to be covered under the warranty; then, Magnetrol will repair or replace the control at no cost

to the purchaser (or owner) other than transportation.

Magnetrol shall not be liable for misapplication, labor claims, direct or consequential damage or expense arising from the installation or use of equipment. There are no other warranties expressed or implied, except special written warranties covering some Magnetrol products.



[magnetrol.com](http://magnetrol.com)

Copyright © 2022 AMETEK Magnetrol USA, LLC

Performance specifications are effective with date of issue and are subject to change without notice.

**BULLETIN: 44-121.7**

**EFFECTIVE: January 2017**

**SUPERSEDES: February 2015**